

[www.samisinstruments.com](http://www.samisinstruments.com)

# SAMIS INSTRUMENT SET PRODUCTS

" We produce for your health... "

SET  
CATALOG

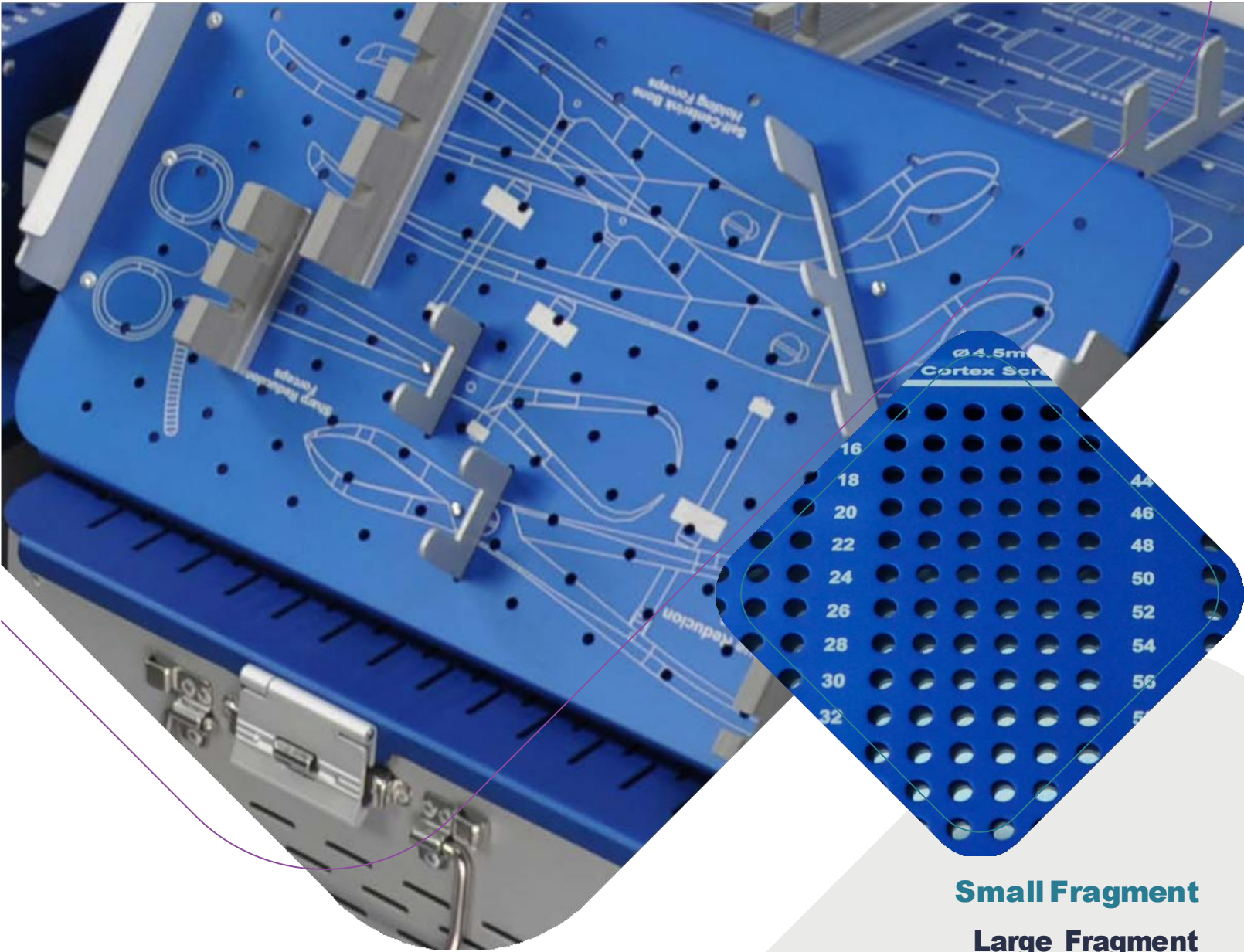

"We produce for your health..."

Ortimplant provides a complete platform of surgical instruments aluminum boxes, silicone holders suitable for the placement of the surgical instruments for all orthopedic surgeries, provide great convenience to surgeons during surgery

**Small Fragment**

**Large Fragment**

**DHS / DCS**

**Screw Removal**

**Pelvic Reconstruction Plate**

**Micro**

**Mini Fragment**

**Maxillofacial**

**Sternum Rib**

**Angled Blade**

**Cable**

**Cannulated Screw**

**Headless Compression Screw**

**Herbert Cannulated Screw**

**Humeral Intramedullary Nail**

**Femur Antegrade**

**Distal Femur Retrograde**

# ORTIMPLANT PRODUCT GROUPS

## ● TRAUMA PRODUCTS

We produce superior designed and functional products made off ISO 5832 - 1 Stainless steel and ISO 5832 - 3 Titanium high quality raw materials, suitable with human anatomy and meticulous quality standart

## ● STERILIZATION CONTAINERS

We produce aluminum sterilization containers suitable for all surgical sets which are convenient, hygienic, safe & which can be used without wrapping with surgical textiles and which can maintain sterilization safety for a long time

## ● TRAUMA INSTRUMENT SETS

Orthopedic surgery instrument sets, including carefully designed surgical instruments aluminum boxes, silicone holders suitable for the placement of the surgical instruments for all orthopedic surgeries, provide great convenience to surgeons during surgery

## ● STERILIZATION BASKETS

We produce perforated stainless steel baskets suitable for all sets of surgical instruments that can be used in sterilization containers or alone

## ● ORTHOPEDIC SURGICAL INSTRUMENTS

We develop and produce ergonomic, convenient and functional, stainless steel orthopedic surgical instruments which increase the success of surgical procedures

## ● ORTHOPEDIC STERILIZATION CONTAINERS

Aluminum perforated boxes, screw racks, silicone holders, surgical instrument trays are produced for all surgical instrument sets, which allow the orthopedic surgical instruments to be stored, transported and sterilized by wrapping surgical textile

"With its obsessive Quality policy "

With its obsessive quality policy and with its open structure to development, Ortimplant goes on its constitution under today's modern institutional structure

### **Short R PFN**

### **New Femoral Reconstruction**

### **APFNA Femur Short**

### **ONT Tibial Intramedullary Nail**

### **Tibial Intramedullary Nail**

### **Intramedullary Nail Removal**

### **Elastic Nail**

### **Spinal PEdicle Screw System**

### **Anterior Cervical**

### **Posterior Cervical Fixation System**

### **Anterior Thoracic & Lumbar**

### **Ayfix External Fixator**

### **Mini Rail External Fixator**

### **Tubular External Fixator**

### **Ilizarov Circular External Fixator**

### **Pediatric Ilizarov Circular External Fixator**

### **Pin-Wire Instrument Set**

### **Flexible Reamer Surgery**

Our expert team has years of experience in development of business and strategy..

From raw materials to services after sales, samis instruments considers to apply Total Quality Management System, With respect to this policy **samis instruments has been certified its Quality with the certificates of CE,**

Samis instruments manufactures orthopaedics implants, sterilization containers and accessories in line with world norms with its high technologic workshop.

Samis instruments increases its success in orthopaedic field everyday by manufacturing new and developed products as a result of investigation and research studies of the specialist physicians and experienced engineers according to needs of global orthopaedic market.

Together with modern background and educated technical team samis instruments aims qualified manufacturing as a goal.

From raw materials to services after sales samis instruments considers to apply Total Quality Management. With respect to this policy samis instruments has been certified its Quality with the certificates of CE, ISO 9001, ISO 13485.

With the aim of more rapid and continuous satisfaction of customer desires, samis instruments educates the employees in advanced stages to increase customer satisfaction under all conditions. With periodically given education seminars samis instruments is in the aim of reaching institutional quality from personal quality and with direction of this goal samis instruments succeeded the communication between employees by meeting all management and technical teams together in social and cultural activities.

samis instruments attributes to national and international sectoral fairs to actively present its current and new products to the medical sector in the world.

With its obsessive Quality policy and with its open structure to developments samis instruments goes on its constution under today's modern insttutional structure.



# INDEX

Small Fragment Locking / Non-Locking Plate	6	APFNA Femur Short Nail	16
Large Fragment Locking / Non-Locking Plate	6	ANT Tibial Intramedullary Nail	17
DHS & DCS Plate	7	Tibial Intramedullary Nail	18
Mini RaIl External Fixator	7	Ayfix External Fixator	18
Pelvic Reconstruction Plate	8	Intramedullary Nail Removal	19
Micro Plate	8	Elastic Nail	19
Mini Fragment Plate	9	Spinal Pedicle Screw System	20
1,5/2,0 mm Maxillofacial Plate	9	Anterior Cervical Plate System	20
2,4 mm Maxillofacial Plate	10	Posterior Cervical Fixation System	21
Sternum Rib Plate	10	Anterior Thoracic & Lumbar Plate System	21
3,5/4,5 mm Angled Blade Plate	10	Screw Removal	22
2,7/3,5/4,0 mm Cannulated Screw	11	Tubular External Fixator S	23
4,5/6,5/7,3 mm Cannulated Screw	11	Tubular External Fixator M	23
3,0/3,5/4,0/5,0/6,5 mm Headless Compression Screw	12	Tubular External Fixator L	24
5,0/6,5 mm Headless Compression Screw	12	Hybrid External Fixator	24
3,0/3,5/4,0 mm Headless Compression Screw	13	Ilizarov Circular External Fixator	25
Humeral Intramedullary Nail	13	Pediatric Ilizarov Circular External Fixator	25
Herbert Screw	13	Wire-Pin	26
Femur Antegrade Intramedullary Nail	14	Flexible Reamer Surgery	26
Distal Femur Retrograde Intramedullary Nail	14	Cable Crimp Block	26
New Femoral Reconstruction Intramedullary Nail	15		

## O3200-0100 SMALL FRAGMENT LOCKING / NON-LOCKING PLATE INSTRUMENT SET

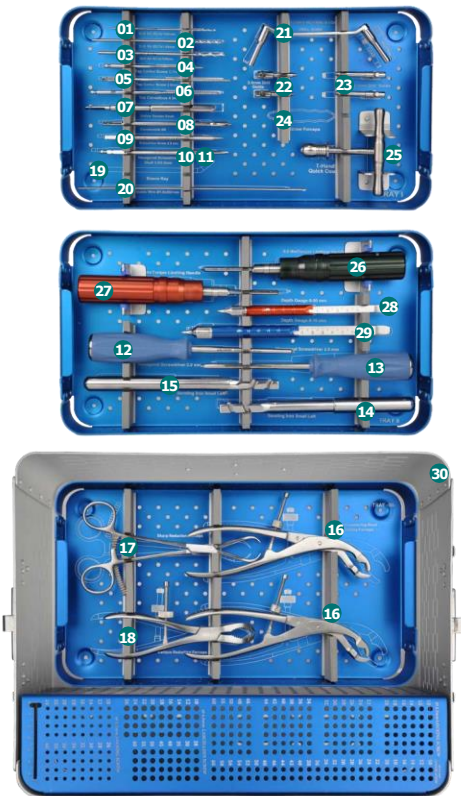

O 3200-0101	DRILL BIT Ø2,0X110 MM
O 3200-0102	DRILL BIT Ø2,7X130 MM
O 3200-0103	DRILL BIT Ø3,2X130 MM
O 3200-0104	TAP FOR CORTEX SCREW 2,7 MM
O 3200-0105	TAP FOR CORTEX SCREW 3,5 MM
O 3200-0106	TAP CANCELLO US 4,0 MM
O 3200-0107	HOLLOW REAMER SMALL
O 3200-0108	COUNTERSINK Ø6,0
O 3200-0109	EXTRACTION SCREW HEXAGONAL 2,5 MM CONICAL
O 3200-0110	HEXAGONAL SCREWDRIVER SHAFT 2,0 MM QUICK COUPLING
O 3200-0111	HEXAGONAL SCREWDRIVER SHAFT 2,5 MM QUICK COUPLING
O 3200-0112	HEXAGONAL SCREWDRIVER 2,0 MM
O 3200-0113	HEXAGONAL SCREWDRIVER 2,5 MM
O 3200-0114	BENDING IRON SMALL RIGHT
O 3200-0115	BENDING IRON SMALL LEFT
O 3200-0116	SELF-CENTERING BONE HOLDING FORCEPS (190 MM)
O 3200-0117	SHARP REDUCTION FORCEP (170 MM)
O 3200-0118	OBLIQUE REDUCTION FORCEP (190 MM)
O 3200-0119	SLEEVE KEY
O 3200-0120	GUIDE WIRE Ø1,8X200 MM
O 3200-0121	NEUTRAL AND LOAD DRILL GUIDE
O 3200-0122	THREADED DRILL GUIDE (SLEEVE) 2,0 MM
O 3200-0123	THREADED DRILL GUIDE (SLEEVE) 2,7 MM
O 3200-0124	SCREW FORCEPS
O 3200-0125	T-HANDLE QUICK COUPLING
O 3200-0126	TORQUE LIMITING HANDLE 0,8 NM
O 3200-0127	TORQUE LIMITING HANDLE 1,5 NM
O 3200-0128	DEPTH GAUGE 0-50 MM
O 3200-0129	DEPTH GAUGE 0-70 MM
O 3200-0130	ALUMINIUM CASE & TRAYS

## O3200-0200 LARGE FRAGMENT LOCKING / NON-LOCKING PLATE INSTRUMENT SET

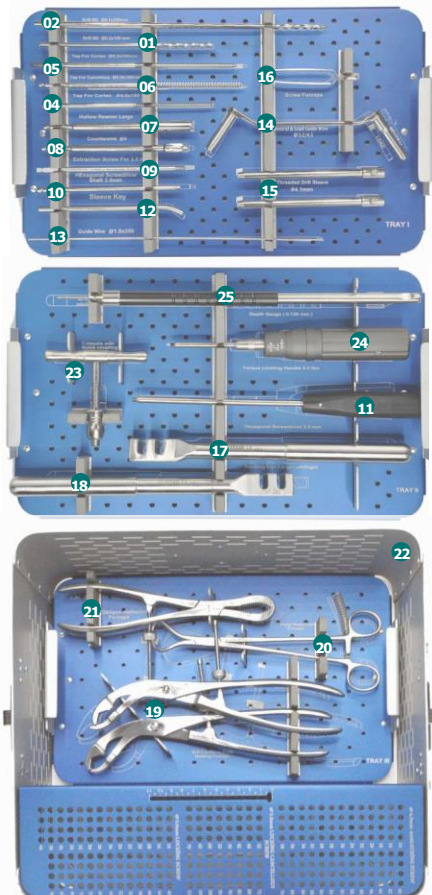

O 3200-0201	DRILL BIT Ø3,2X150 MM
O 3200-0202	DRILL BIT Ø4,1X250 MM
O 3200-0204	TAP FOR CORTEX SCREW 4,5 MM
O 3200-0205	TAP FOR CORTEX SCREW 5,0 MM
O 3200-0206	TAP CANCELLO US 5,0 MM
O 3200-0207	HOLLOW REAMER LARGE
O 3200-0208	COUNTERSINK Ø8,0
O 3200-0209	EXTRACTION SCREW HEXAGONAL 3,5 MM CONICAL
O 3200-0210	HEXAGONAL SCREWDRIVER SHAFT 3,5 MM QUICK COUPLING
O 3200-0211	HEXAGONAL SCREWDRIVER 3,5 MM
O 3200-0212	SLEEVE KEY
O 3200-0213	GUIDE WIRE Ø1,8X250 MM
O 3200-0214	NEUTRAL AND LOAD DRILL GUIDE 3,2/4,5 MM
O 3200-0215	THREADED DRILL GUIDE (SLEEVE) 4,1 MM
O 3200-0216	SCREW FORCEPS
O 3200-0217	BENDING IRON LARGE RIGHT
O 3200-0218	BENDING IRON LARGE LEFT
O 3200-0219	SELF-CENTERING BONE HOLDING FORCEPS (270 MM)
O 3200-0220	SHARP REDUCTION FORCEP (200 MM)
O 3200-0221	OBLIQUE REDUCTION FORCEP (230 MM)
O 3200-0222	ALUMINIUM CASE & TRAYS (LARGE)
O 3200-0223	T-HANDLE QUICK COUPLING
O 3200-0224	TORQUE LIMITING HANDLE 4,0 NM
O 3200-0225	DEPTH GAUGE 0-120 MM
O 3200-0226	THREADED DRILL GUIDE (SLEEVE) 4,5 MM

## O4200-0500 DHS & DCS INSTRUMENT SET

O4200-0501	T-HANDLE QUICKCOUPLING
O4200-0502	TAP CORTEX SCREW 4,5 MM
O4200-0503	TAP CORTEX SCREW 5,0 MM
O4200-0504	SIMPLE DRILL CLIP
O4200-0505	NEUTRAL AND LOAD DRILL GUIDE 3,2-4,5 MM
O4200-0506	HEXAGONAL SCREWDRIVER SW 3,5 MM W QUICK COUPLING
O4200-0507	DRILL BIT Ø4,1X250 MM
O4200-0508	DRILL BIT Ø3,2X150 MM
O4200-0509	LAG SCREW DEPTH MEASURING DEVICE
O4200-0510	TAP FOR LAG SCREW
O4200-0511	THREADED K-WIRE Ø1,8X230 MM
O4200-0512	DHS/DCS IMPACTOR LARGE
O4200-0513	DEPTH GAUGE(0-120 MM)
O4200-0514	DHS/DCS IMPACTOR SMALL
O4200-0515	DHS/DCS WRENCH 2
O4200-0516	DHS/DCS WRENCH 1
O4200-0517	HEXAGONAL SCREWDRIVER SW 3,5 MM
O4200-0518	DCS ANGLE GUIDE 95 °
O4200-0519	DHS ANGLE GUIDE 135 °
O4200-0520	DHS REAMER
O4200-0521	DCS REAMER
O4200-0522	ALUMINIUM BOX
O4200-0523	SCREW FORCEPS
O4200-0524	THREADED DRILL GUIDE(SLEEVE) 4,1 MM

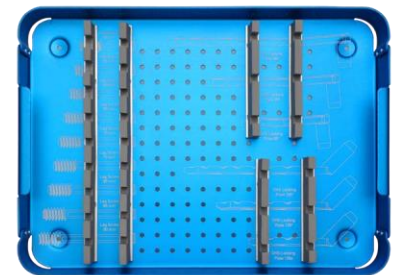
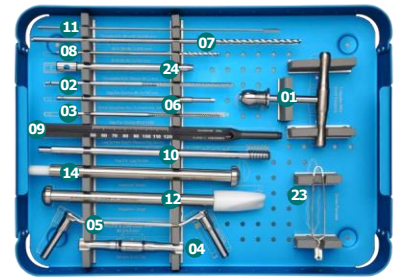

## O5200-0200 MINI RAIL EXTERNAL FIXATOR INSTRUMENT SET

O5200-0201	MINI RAIL FIXATOR SHORT
O5200-0202	MINI RAIL FIXATOR MEDIUM
O5200-0203	MINI RAIL FIXATOR LONG
O5200-0204	MINI RAIL FIXATOR X LONG
O5200-0205	MINI RAIL FIXATOR VERTICAL AXIS
O5200-0206	MINI RAIL FIXATOR HORIZONTAL AXIS
O5200-0207	MINI RAIL FIXATOR HORIZONTAL AXIS 90°
O5200-0209	PROTECTION SLEEVE
O5200-0210	TROCHAR
O5200-0211	DRILL SLEEVE Ø1,2 MM
O5200-0212	DRILL SLEEVE Ø1,5 MM
O5200-0213	DRILL SLEEVE Ø1,8 MM
O5200-0214	HEXAGONAL WRENCH Ø3 MM
O5200-0215	DRILL BIT Ø1,2X70 MM
O5200-0216	DRILL BIT Ø1,5X70 MM
O5200-0217	DRILL BIT Ø1,8X80 MM
O5200-0218	SCHANZ SCREW Ø1,5 MM X 70 MM
O5200-0219	SCHANZ SCREW Ø1,5 MM X 90 MM
O5200-0220	SCHANZ SCREW Ø2,0 MM X 70 MM
O5200-0221	SCHANZ SCREW Ø2,0 MM X 90 MM
O5200-0222	SCHANZ SCREW Ø2,5 MM X 80 MM
O5200-0223	SCHANZ SCREW Ø2,5 MM X 100 MM
O5200-0224	T-HANDLE WITH JACOB'S CHUCK
O5200-0225	ALUMINIUM BOX
O5200-0226	TROCHAR SLEEVE
O5200-0227	SCHANZ SLEEVE Ø1,5 MM
O5200-0228	SCHANZ SLEEVE Ø2,0 MM
O5200-0229	SCHANZ SLEEVE Ø2,5 MM
O5200-0230	DRILL BIT Ø1,2 X90 MM
O5200-0231	DRILL BIT Ø1,5X90 MM
O5200-0232	DRILL BIT Ø1,8 X100 MM

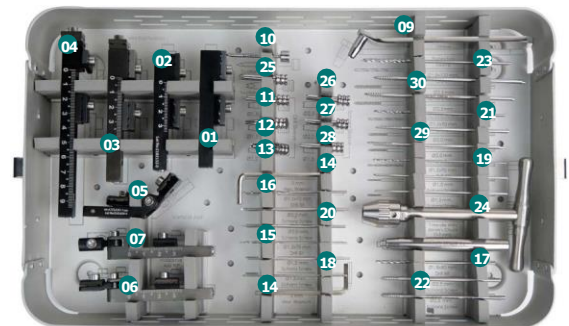

## 04200-0800 PELVIC RECONSTRUCTION PLATE INSTRUMENT SET

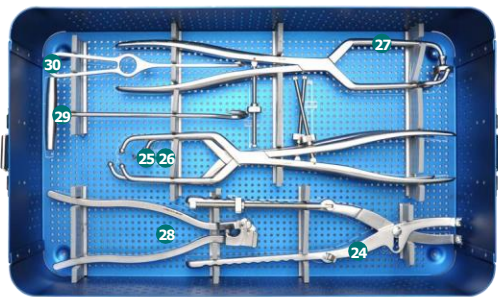
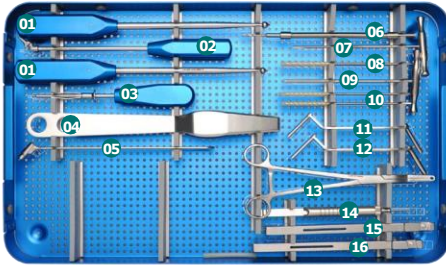
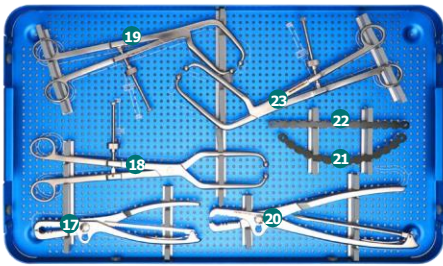

04200-0801	STRAIGHT BALL SPIKE 300 MM
04200-0802	UNIVERSAL HEXAGONAL SCREWDRIVER SW 2,5
04200-0803	HEXAGONAL SCREWDRIVER SW 2,5
04200-0804	RETRACTOR
04200-0805	DRILL GUIDER Ø2,5
04200-0806	FLEXIBLE DRILL BIT Ø2,5
04200-0807	TAP Ø3,5
04200-0808	DRILL BIT Ø3,0
04200-0809	TAP Ø4,0
04200-0810	DRILL BIT Ø2,5
04200-0811	DRILL-TAP GUIDER Ø2,5-Ø3,5
04200-0812	DRILL-TAP GUIDER Ø3,0-Ø4,0
04200-0813	SCREW HOLDER FORCEP
04200-0814	DEPTH GAUGE 0-70 MM
04200-0815	BENDING IRON LEFT
04200-0816	BENDING IRON RIGHT
04200-0817	BONE HOLDING FORCEP 200 MM
04200-0818	REDUCTION FORCEP STRAIGHT
04200-0819	REDUCTION FORCEP CURVED 250 MM
04200-0820	BONE HOLDING FORCEP 250 MM
04200-0821	PELVIC MOULD PLATE
04200-0822	RECONSTRUCTION MOULD PLATE
04200-0823	REDUCTION FORCEP CURVED 280 MM
04200-0824	PELVIC RECONSTRUCTION FORCEP LARGE 330 MM
04200-0825	PELVIC REDUCTION FORCEP WITH 2 BALL-TIPPED 400 MM
04200-0826	PELVIC REDUCTION FORCEP WITH 2 HIGH-LOW-BALL-TIPPED 400 MM
04200-0827	PELVIC REDUCTION FORCEP WITH 3 BALL-TIPPED 400 MM
04200-0828	PLATE BENDER
04200-0829	BONE HOOK
04200-0830	T-HANDLE BONE HOOK
04200-0831	ALUMINIUM CASE & TRAYS

## 04200-0300 MICRO PLATE INSTRUMENT SET

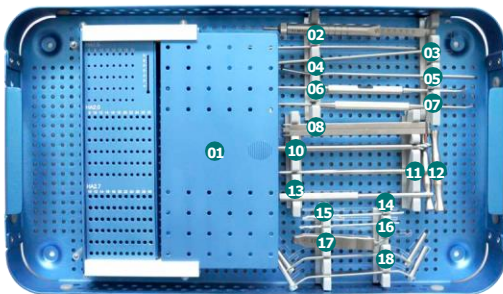

04200-0301	SCREW BOX(1,5/2,0/2,7 MM)
04200-0302	DEPTH GAUGE(0-40 MM)
04200-0303	BONE ELEVATOR LARGE
04200-0304	BONE ELEVATOR MEDIUM
04200-0305	BONE ELEVATOR SMALL
04200-0306	DISSECTOR 5 MM
04200-0307	DISSECTOR 3 MM
04200-0308	BENDING IRON
04200-0309	COUNTERSINK HO 2,7
04200-0310	COUNTERSINK HO 2,0
04200-0311	TAP HO2,0
04200-0312	TAP HO2,7
04200-0313	SHARP HOOK
04200-0314	DRILL BIT (Ø1,5)
04200-0315	DRILL BIT (Ø2,0)
04200-0316	SCREW FORCEPS
04200-0317	GUIDE(Ø2,0/Ø2,7)
04200-0318	GUIDE(Ø1,5/Ø2,0)
04200-0319	PLATE-BENDING FORCEPS
04200-0320	WIRE CUTTER
04200-0321	BONE RIBBING RONGEUR
04200-0322	POINTED-TIP REDUCTION FORCEPS
04200-0323	BENT-TIP REDUCTION FORCEPS
04200-0324	PLATE-HOLD FORCEPS
04200-0325	HEXAGONAL SCREWDRIVER SW2,0
04200-0326	SKIN RETRACTOR
04200-0327	ALUMINIUM BOX

## O4200-0400 MINI FRAGMENT PLATE INSTRUMENT SET

O4200-0401	TAP HA2,4
O4200-0402	GUIDE 1,5/2,4
O4200-0403	DRILL BIT 1,5X100 MM
O4200-0404	TAP HA2,0
O4200-0405	GUIDE 1,2/2,0
O4200-0406	DRILL BIT 1,2X100 MM
O4200-0407	TAP HA2,7
O4200-0408	GUIDE 2,0/2,7
O4200-0409	DRILL BIT 2,0X100 MM
O4200-0410	PLATE-HOLDING FORCEPS
O4200-0411	PLATE-BENDING FORCEPS
O4200-0412	RETRACTORS 1X3
O4200-0413	DISSECTOR 5MM
O4200-0414	DISSECTOR 3MM
O4200-0415	SHARP HOOK
O4200-0416	BENDING IRON
O4200-0417	WIRE CUTTER
O4200-0418	T-HANDLE QUICK COUPLING
O4200-0419	SCREW FORCEPS
O4200-0420	POINTED-TIP REDUCTION FORCEPS
O4200-0421	BENT-TIP REDUCTION FORCEPS
O4200-0422	SHAPE-MADE FORCEPS
O4200-0423	QUICK COUPLING SCREWDRIVER HEXAGONAL (SW2,0)
O4200-0424	COUNTERSINK
O4200-0425	DEPTH GAUGE 0-50MM
O4200-0426	SKIN RETRACTOR
O4200-0427	ALUMINIUM BOX
O4200-0428	DEPTH GAUGE 0-30MM
O4200-0429	STRAIGHT-HANDLE QUICK COUPLING
O4200-0430	HEXAGONAL SCREWDRIVER SW 2,0
O4200-0431	ALUMINIUM BOX

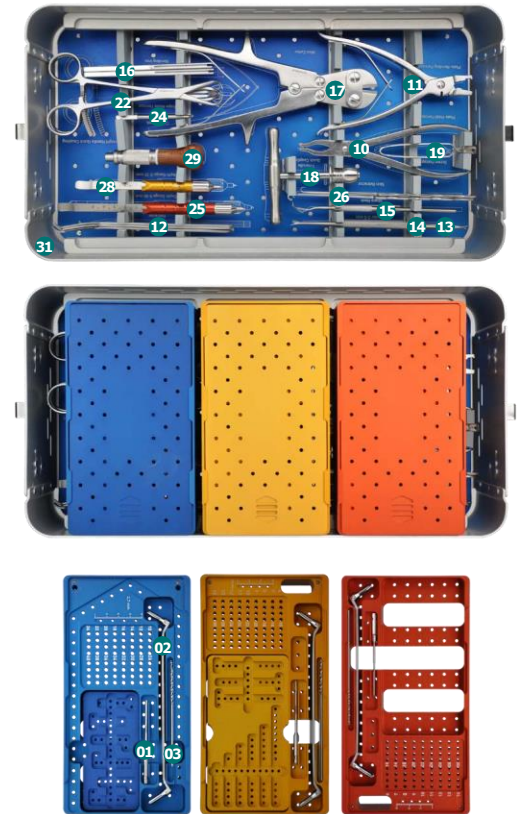

## O3128-0100 1,5/2,0 MM MAXILLOFACIAL PLATE INSTRUMENT SET

O3128-0101	HOLLOW REAMER 1,5 MM
O3128-0102	HOLLOW REAMER 2,0 MM
O3128-0103	SCREWDRIVER FOR 1,5 MM SCREW
O3128-0104	SCREWDRIVER FOR 2,0 MM SCREW
O3128-0105	SCREWDRIVER FOR 2,0 MM SCREW
O3128-0106	LIMITED DRILL BIT 1,6X5 MM
O3128-0107	LIMITED DRILL BIT 1,6X6 MM
O3128-0108	LIMITED DRILL BIT 1,6X7 MM
O3128-0109	LIMITED DRILL BIT 1,6X9 MM
O3128-0110	LIMITED DRILL BIT 1,6X11MM
O3128-0111	LIMITED DRILL BIT 1,6X13 MM
O3128-0112	LIMITED DRILL BIT 1,6X15 MM
O3128-0113	LIMITED DRILL BIT 1,1X4 MM
O3128-0114	LIMITED DRILL BIT 1,1X5 MM
O3128-0115	LIMITED DRILL BIT 1,1X6 MM
O3128-0116	LIMITED DRILL BIT 1,1X7 MM
O3128-0117	LIMITED DRILL BIT 1,1X9 MM
O3128-0118	LIMITED DRILL BIT 1,1X11 MM
O3128-0119	QUICK COUPLING HANDLE
O3128-0120	GUIDE 1,1 MM & 1,6 MM
O3128-0121	ALUMINIUM BOX

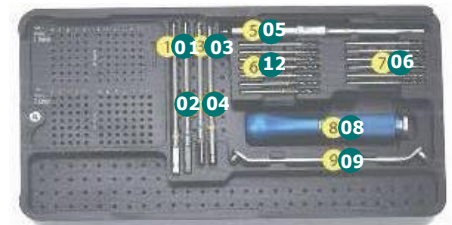

## 04200-1000 2,4 MM MAXILLOFACIAL PLATE INSTRUMENT SET

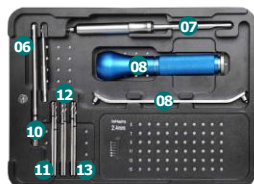
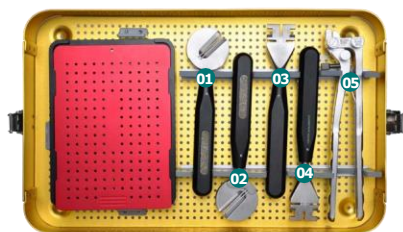

03128-0201	DEPTH GAUGE 0-30 MM
03128-0202	QUICK COUPLING HANDLE
03128-0203	GUIDE 1,9 MM
03128-0204	COUNTERSINK DRILL 2,0 MM
03128-0205	SCREWDRIVER FOR 2,4 MM SCREW
03128-0206	LIMITED DRILL BIT 1,9*5 MM
03128-0207	LIMITED DRILL BIT 1,9*7 MM
03128-0208	LIMITED DRILL BIT 1,9*9 MM
03128-0209	LIMITED DRILL BIT 1,9*11 MM
03128-0210	LIMITED DRILL BIT 1,9*13 MM
03128-0211	LIMITED DRILL BIT 1,9*15 MM
03128-0212	PLATE SHAPING FORCEPS ROUND
03128-0213	PLATE SHAPING FORCEPS ROUND
03128-0214	PLATE BENDER
03128-0215	PLATE BENDER
03128-0216	PLATE SHAPING FORCEPS
03128-0217	ALUMINIUM BOX

## 04200-0900 STERNUM RIB PLATE INSTRUMENT SET

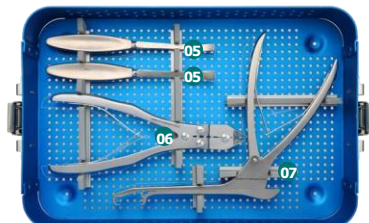
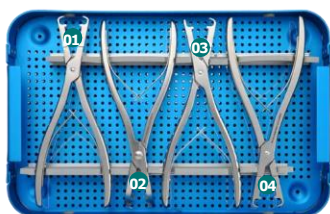

04200-0901	REDUCTION FORCEPS DOUBLE LARGE
04200-0902	REDUCTION FORCEPS CURVED
04200-0903	REDUCTION FORCEPS DOUBLE SMALL
04200-0904	REDUCTION FORCEPS SINGLE
04200-0905	PLATE INSERT FORCEPS
04200-0906	RIB PLATE CUTTER
04200-0907	PERIOSTEAL ELEVATOR 9 MM
04200-0908	PERIOSTEAL ELEVATOR 12 MM
04200-0909	ALUMINIUM BOX

## 04200-1600 3,5/4,5 MM ANGLED BLADE PLATE INSTRUMENT SET

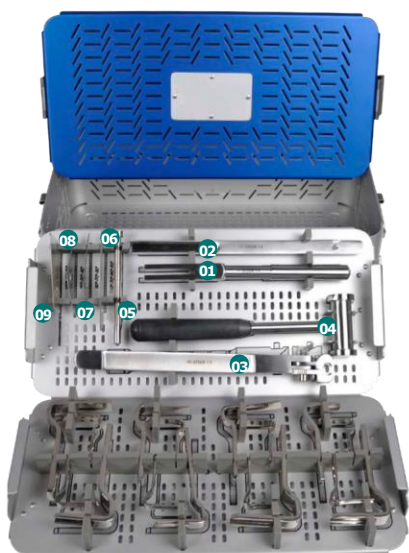

04200-1601	INSERTER - EXTRACTOR FOR ADOLESCENT AND CHILDREN
04200-1602	INSERTER-EXTRACTOR FOR ADULTS
04200-1603	IMPACTOR FOR ANGULAR PLATES
04200-1604	SLOTTED HAMMER
04200-1605	CHISEL GUIDE
04200-1606	TRIANGULAR POSITIONING PLATE 80/70/30
04200-1607	TRIANGULAR POSITIONING PLATE 90/50/40
04200-1608	TRIANGULAR POSITIONING PLATE 100/60/20
04200-1609	QUADRANGULAR POSITIONING PLATE 110/90/90/70

## 04200-0600 2,7-3,5-4,0 MM CANNULATED SCREW INSTRUMENT SET

04200-0601	MEASURING DEVICE (0-70 MM)
04200-0602	CLEANING STYLET (Ø0,8X130 MM)
04200-0603	CANNULATED COUNTERSINK Ø6,0 MM
04200-0604	CANNULATED DRILL BIT (Ø2,2X100)
04200-0605	CANNULATED HEXAGONAL SCREWDRIVER SHAFT 2,0MM, QUICK COUPLING
04200-0606	CANNULATED TAP FOR 2,7 MM C.SCREW
04200-0607	CANNULATED SCREWDRIVER HEXAGONAL 2,5MM
04200-0608	CANNULATED COUNTERSINK Ø4,0 MM
04200-0609	HEXAGONAL KEY SW 2,5
04200-0610	Ø5,0/2,2 MM DRILL SLEEVE
04200-0611	DRILL SLEEVE (Ø3,2) & PROTECTION SLEEVE (Ø5,0)
04200-0612	ALUMINIUM BOX
04200-0613	CANNULATED HEXAGONAL SCREWDRIVER SHAFT, 2,5MM, QUICK COUPLING
04200-0614	CANNULATED SCREWDRIVER HEXAGONAL 2,0MM
04200-0615	HEXAGONAL SCREWDRIVER SHAFT, 2,0MM, QUICK COUPLING
04200-0616	HEXAGONAL SCREWDRIVER SHAFT, 2,5MM, QUICK COUPLING
04200-0617	SCREWDRIVER HEXAGONAL 2,0MM
04200-0618	SCREWDRIVER HEXAGONAL 2,5MM
04200-0619	SCREW FORCEP
04200-0620	T-HANDLE QUICK COUPLING
04200-0621	CANNULATED TAP FOR 3,5 MM C.SCREW
04200-0622	CANNULATED TAP FOR 4,0 MM C.SCREW
04200-0623	GUIDE WIRE ( Ø0,8X130 MM )
04200-0624	Ø5,0/0,8 MM GUIDE WIRE SLEEVE
04200-0625	CLEANING STYLET (Ø1,0X130 MM)
04200-0626	GUIDE WIRE ( Ø1,0X130 MM )
04200-0627	Ø5,0/1,0 MM GUIDE WIRE SLEEVE
04200-0628	CANNULATED DRILL BIT (Ø3,2X130)
04200-0629	Ø5,0/2,7 MM DRILL SLEEVE
04200-0630	CANNULATED DRILL BIT (Ø2,7X130)

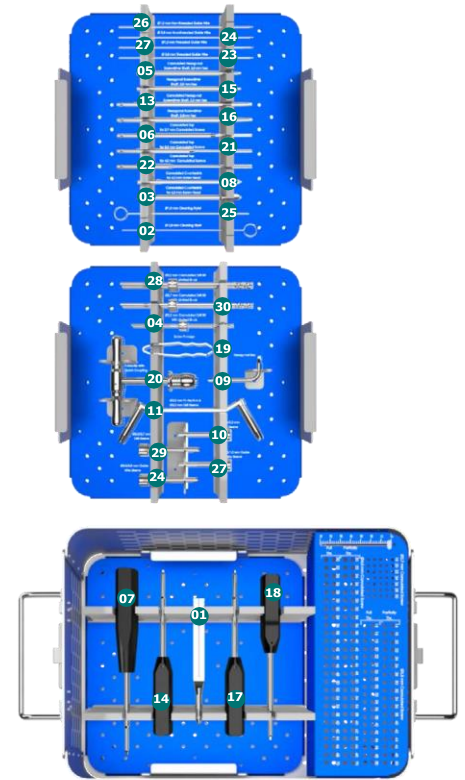

## 04200-7300 4,5-6,5-7,3 MM CANNULATED SCREW INSTRUMENT SET

04200-7301	ADJUSTABLE PARALLEL WIRE GUIDE
04200-7302	CANNULATED COUNTERSINK Ø8,0
04200-7303	CANNULATED DRILL BIT ( Ø3,2X180 MM )
04200-7304	CANNULATED DRILL BIT ( Ø4,5X250 MM )
04200-7305	CANNULATED HEXAGONAL SCREWDRIVER 3,5 HEX
04200-7306	CANNULATED TAP FOR Ø4,5 MM CANNULATED SCREW
04200-7307	CANNULATED TAP FOR Ø6,5 MM CANNULATED SCREW
04200-7308	CANNULATED TAP FOR Ø7,3 MM CANNULATED SCREW
04200-7309	CLEANING STYLET ( Ø1,4X250 MM )
04200-7310	CLEANING STYLET ( Ø2,0X250 MM )
04200-7311	DRILL SLEEVE Ø3,2
04200-7312	GUIDE WIRE SLEEVE Ø2,0
04200-7313	GUIDE WIRE SLEEVE Ø1,4
04200-7314	HEXAGONAL KEY 3,0MM HEX
04200-7315	HEXAGONAL SCREWDRIVER 3,5MM HEX
04200-7316	HEXAGONAL SCREWDRIVER SHAFT, 3,5 MM, QUICK COUPLING
04200-7317	HEXAGONAL SCREWDRIVER SHAFT, 3,5 MM, QUICK COUPLING CANNULATED
04200-7318	HOLDING SCREW
04200-7319	MEASURING DEVICE
04200-7320	MULTIPLE WIRE GUIDE
04200-7321	Ø2,5 MM TROCAR
04200-7322	PROTECTION SLEEVE( Ø5,3) & DRILL SLEEVE ( Ø4,5)
04200-7323	THREADED GUIDE WIRE ( Ø1,4X250 MM )
04200-7324	THREADED GUIDE WIRE ( Ø2,0X250 MM )
04200-7325	THREADED DRILL SLEEVE Ø4,5 MM
04200-7326	THREADED TAP SLEEVE Ø7,3 MM
04200-7327	WRENCH FOR ADJUSTABLE PARALLEL WIRE GUIDE
04200-7328	T-HANDLE WITH QUICK COUPLING
04200-7329	BOX
04200-7330	LID
04200-7331	TRAYS
04200-7332	SCREW TRAY



## O4200-1200 3,0/3,5/4,0/5,0/6,5 MM HEADLESS COMPRESSION SCREW INSTRUMENT SET

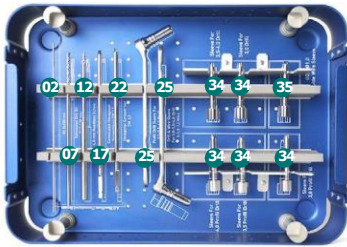
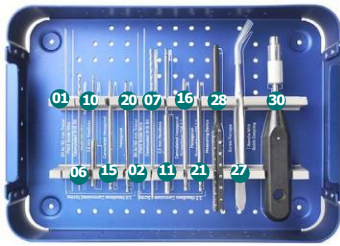

O4200-1201	Ø0,8 MM SINGLE TROCAR GUIDE WIRE
O4200-1202	Ø1,0 MM SINGLE TROCAR GUIDE WIRE
O4200-1203	Ø1,5MM SINGLE TROCAR GUIDE WIRE
O4200-1204	Ø2,0MM SINGLE TROCAR GUIDE WIRE
O4200-1205	Ø2,0MM THREADED TROCAR GUIDE WIRE
O4200-1206	Ø2,0 MM CANNULATED DRILL BIT
O4200-1207	Ø2,6 MM CANNULATED DRILL BIT
O4200-1208	Ø3,4 MM CANNULATED DRILL BIT
O4200-1209	Ø4,5 MM CANNULATED DRILL BIT
O4200-1210	CANNULATED PROFIL DRILL FOR Ø3,0 MM SCREW
O4200-1211	CANNULATED PROFIL DRILL FOR Ø3,5 MM SCREW
O4200-1212	CANNULATED PROFIL DRILL FOR Ø4,0 MM SCREW
O4200-1213	CANNULATED PROFIL DRILL FOR Ø5,0 MM SCREW
O4200-1214	CANNULATED PROFIL DRILL FOR Ø6,5 MM SCREW
O4200-1215	CANNULATED HEXAGONAL QUICK COUPLING SW 1,5 MM
O4200-1216	CANNULATED HEXAGONAL QUICK COUPLING SW 2,0 MM
O4200-1217	CANNULATED HEXAGONAL QUICK COUPLING SW 2,5 MM
O4200-1218	CANNULATED HEXAGONAL QUICK COUPLING SW 3,0 MM
O4200-1219	CANNULATED HEXAGONAL QUICK COUPLING SW 3,5 MM
O4200-1220	HEXAGONAL QUICK COUPLING SW 1,5 MM
O4200-1221	HEXAGONAL QUICK COUPLING SW 2,0 MM
O4200-1222	HEXAGONAL QUICK COUPLING SW 2,5 MM
O4200-1223	HEXAGONAL QUICK COUPLING SW 3,0 MM
O4200-1224	HEXAGONAL QUICK COUPLING SW 3,5 MM
O4200-1225	PARALEL WIRE GUIDE 3,0-3,5-4,0 MM
O4200-1226	PARALEL WIRE GUIDE 5,0-6,5 MM
O4200-1227	SCREW FORCEPS
O4200-1228	MEASURING DEVICE 3,0-3,5-4,0 MM
O4200-1229	MEASURING DEVICE 5,0-6,5 MM
O4200-1230	T-HANDLE WITH QUICK COUPLING
O4200-1231	I-HANDLE WITH QUICK COUPLING
O4200-1232	SHARP HOOK
O4200-1233	ALUMINIUM CASE

## O4202-1200 5,0/6,5 MM HEADLESS COMPRESSION SCREW INSTRUMENT SET

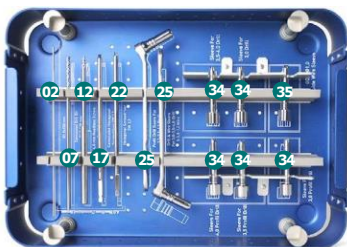
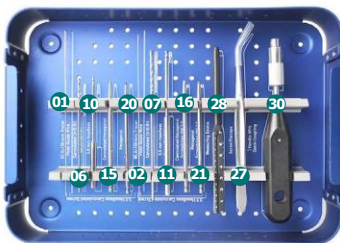

O4202-1203	Ø1,5MM SINGLE TROCAR GUIDE WIRE
O4202-1204	Ø2,0MM SINGLE TROCAR GUIDE WIRE
O4202-1205	Ø2,0MM THREADED TROCAR GUIDE WIRE
O4202-1208	Ø3,4 MM CANNULATED DRILL BIT
O4202-1209	Ø4,5 MM CANNULATED DRILL BIT
O4202-1213	CANNULATED PROFIL DRILL FOR Ø5,0 MM SCREW
O4202-1214	CANNULATED PROFIL DRILL FOR Ø6,5 MM SCREW
O4202-1218	CANNULATED HEXAGONAL QUICK COUPLING SW 3,0 MM
O4202-1219	CANNULATED HEXAGONAL QUICK COUPLING SW 3,5 MM
O4202-1220	HEXAGONAL QUICK COUPLING SW 1,5 MM
O4202-1223	HEXAGONAL QUICK COUPLING SW 3,0 MM
O4202-1224	HEXAGONAL QUICK COUPLING SW 3,5 MM
O4202-1226	PARALEL WIRE GUIDE 5,0-6,5 MM
O4202-1227	SCREW FORCEPS
O4202-1229	MEASURING DEVICE 5,0-6,5 MM
O4202-1230	T-HANDLE WITH QUICK COUPLING
O4202-1232	SHARP HOOK
O4202-1235	MINI BOX
O4202-1236	ALUMINIUM BOX

## O4201-1200 3,0/3,5/4,0 MM HEADLESS COMPRESSION SCREW INSTRUMENT SET

O4201-1201	Ø0,8 MM SINGLE TROCAR GUIDE WIRE
O4201-1202	Ø1,0 MM SINGLE TROCAR GUIDE WIRE
O4201-1206	Ø2,0 MM CANNULATED DRILL BIT
O4201-1207	Ø2,6 MM CANNULATED DRILL BIT
O4201-1210	CANNULATED PROFIL DRILL FOR Ø3,0 MM SCREW
O4201-1211	CANNULATED PROFIL DRILL FOR Ø3,5 MM SCREW
O4201-1212	CANNULATED PROFIL DRILL FOR Ø4,0 MM SCREW
O4201-1215	CANNULATED HEXAGONAL QUICK COUPLING SW 1,5 MM
O4201-1216	CANNULATED HEXAGONAL QUICK COUPLING SW 2,0 MM
O4201-1217	CANNULATED HEXAGONAL QUICK COUPLING SW 2,5 MM
O4201-1220	HEXAGONAL QUICK COUPLING SW 1,5 MM
O4201-1221	HEXAGONAL QUICK COUPLING SW 2,0 MM
O4201-1222	HEXAGONAL QUICK COUPLING SW 2,5 MM
O4201-1234	PROFIL DRILL SLEEVE FOR 3,0/3,5/4,0 MM PROFIL DRILL
O4201-1235	DRILL&WIRE SLEEVE FOR 2,0/2,7 DRILL /0,8/1,0 WIIRE
O4201-1227	SCREW FORCEPS
O4201-1228	MEASURING DEVICE 3,0-3,5-4,0 MM
O4201-1231	I-HANDLE WITH QUICK COUPLING
O4201-1237	MINI BOX
O4201-1238	ALUMINIUM BOX

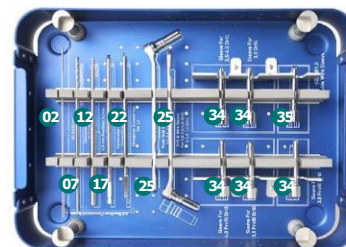
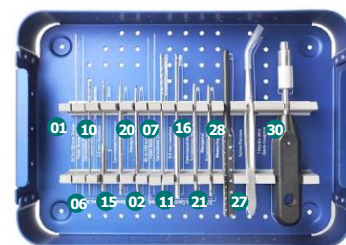

## O4200-1500 HERBERT CANNULATED SCREW INSTRUMENT SET

O4200-1501	Ø2,0 MM SCREWDRIVER HEXAGONAL
O4200-1502	Ø2,0 MM CANNULATED SCREWDRIVER HEXAGONAL
O4200-1503	CLEANING STYLET
O4200-1504	KIRSCHNER WIRE
O4200-1505	Ø2,2X150 MM CANNULATED DRILL BIT
O4200-1506	MEASURING DEVICE
O4200-1507	PARALLEL SLEEVE
O4200-1508	SCREW FORCEPS
O4200-1509	ALUMINIUM CASE & TRAYS

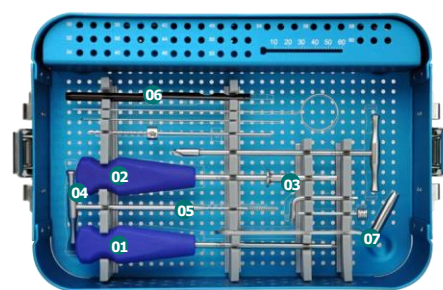

## O1200-0100 HUMERAL INTRAMEDULLARY NAIL INSTRUMENT SET

O1200-0101	AWL
O1200-0102	QUICK COUPLING T-HANDLE
O1200-0103	SLEEVE Ø8-Ø6
O1200-0104	HUMERUS APPARATUS 160 MM
O1200-0105	OPEN WRENCH
O1200-0106	DRILL BIT Ø5,2 WITH T-HANDLE
O1200-0107	TAP Ø3,5
O1200-0108	SCREWDRIVER SW 2,5
O1200-0109	DISTAL POSITIONING FRAME
O1200-0110	DEPTH GAUGE 0-60 MM
O1200-0111	DRILL BIT Ø2,9X250
O1200-0112	DRILL BIT Ø5,2X250
O1200-0114	REAMER Ø8,5X340
O1200-0115	REAMER Ø8X340
O1200-0116	REAMER Ø7,0X340
O1200-0117	HAMMER
O1200-0118	GUIDE ROD
O1200-0119	UNIVERSAL JOINT
O1200-0120	GAUGE CANNULA
O1200-0121	HEXAGONAL WRENCH SW 5,0
O1200-0122	DRILL SLEEVE Ø8-Ø5,2
O1200-0123	SLEEVE Ø10-Ø8,0
O1200-0124	LOCATION ROD
O1200-0125	FIXED CONNECTOR
O1200-0126	NAIL CONNECTOR
O1200-0127	PROXIMAL GUIDE
O1200-0128	DISTAL GUIDE
O1200-0129	SIGHTING DEVICE HANDLE
O1200-0130	GUIDE WIRE Ø2,0
O1200-0131	ALUMINIUM BOX

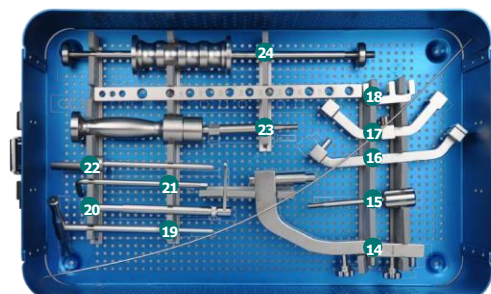
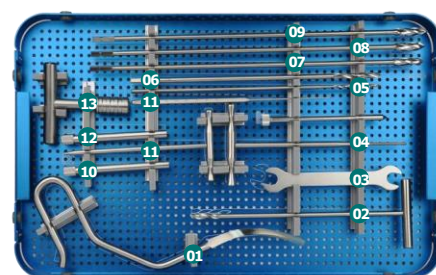

## O1200-0300 FEMUR ANTEGRADE INTRAMEDULLARY NAIL INSTRUMENT SET

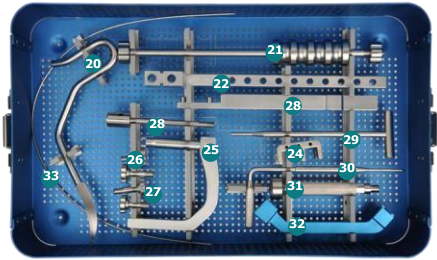
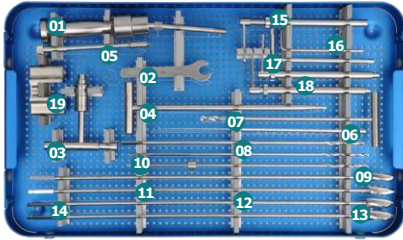
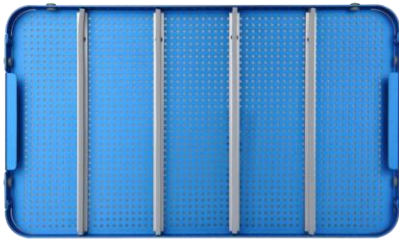

O 1200-0301	UNIVERSAL JOINT
O 1200-0302	OPEN WRENCH
O 1200-0303	QUICK COUPLING T-HANDLE
O 1200-0304	SCREWDRIVERSW 3,5
O 1200-0305	TRO CAR Ø8
O 1200-0306	DEPTH GAUGE 10-100 MM
O 1200-0307	T-HANDLE DRILL BIT Ø 5,2
O 1200-0308	DRILL BIT Ø 5,2X300
O 1200-0309	DRILL BIT WITH LIMITATOR Ø4,0X300
O 1200-0310	DRILL BIT Ø 4,0X300
O 1200-0311	REAMER Ø10
O 1200-0312	REAMER Ø11
O 1200-0313	REAMER Ø12
O 1200-0314	REAMER Ø13
O 1200-0315	DRILL SLEEVE Ø5,2
O 1200-0316	HEXAGONAL WRENCH SW 3,0
O 1200-0317	HEXAGONAL WRENCH SW 5,0
O 1200-0318	DRILL SLEEVE Ø4,0
O 1200-0319	FEMUR APPARATUS
O 1200-0320	AWL
O 1200-0321	HAMMER
O 1200-0322	GUIDE ROD
O 1200-0323	CONNECTOR ROD
O 1200-0324	FIXED CONNECTOR
O 1200-0325	SIGHTING DEVICE HANDLE
O 1200-0326	BOLT M8X32L
O 1200-0327	BOLT M8X41L
O 1200-0328	NAIL CONNECTOR
O 1200-0329	LOCATION ROD
O 1200-0330	LOCATION FORCEP
O 1200-0331	CONNECTOR
O 1200-0332	DISTAL GUIDE
O 1200-0333	GUIDE WIRE
O 1200-0334	ALUMINIUM BOX

## O1200-0400 DISTAL FEMUR RETROGRADE & SHORT R PFN INTRAMEDULLARY NAIL INSTRUMENT SET

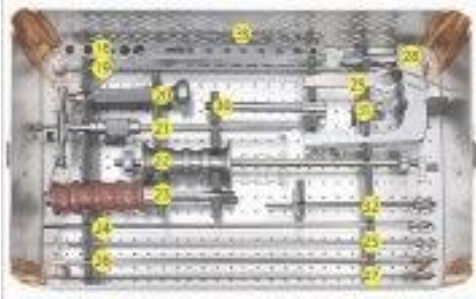
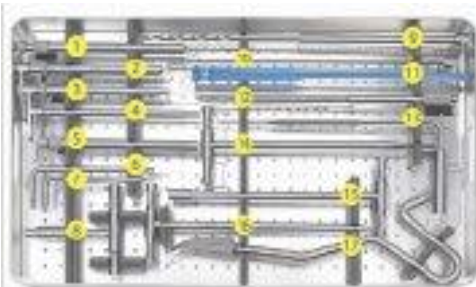

O 1200-0401	GUIDE DRILL + SLEEVE
O 1200-0402	GUIDE DRILL + SLEEVE
O 1200-0403	GUIDE DRILL + SLEEVE
O 1200-0404	GUIDE DRILL + SLEEVE
O 1200-0405	FORCING CONE
O 1200-0406	L- WRENCH LARGE
O 1200-0407	L- WRENCH SMALL
O 1200-0408	T-HANDLE QUICK COUPLING
O 1200-0409	SLEEVE + DRILL BIT
O 1200-0410	DRILL BIT WITH LIMITATOR Ø3,5
O 1200-0411	WIRE DEPTH GAUGE
O 1200-0412	DEPTH GAUGE
O 1200-0413	L-SHAPED LOCATION FORCEPS
O 1200-0414	TAP
O 1200-0415	WRENCH
O 1200-0416	LOCATION FORCEPS
O 1200-0417	AWL
O 1200-0418	GUIDE ROD
O 1200-0419	K-WIRE
O 1200-0420	STRAIGHT HANDLE
O 1200-0421	T-LOCATION FORCEPS
O 1200-0422	IMPACTOR AND EXTRACTOR
O 1200-0423	UNIVERSAL JOINT
O 1200-0424	REAMER Ø10
O 1200-0425	REAMER Ø11
O 1200-0426	REAMER Ø12
O 1200-0427	REAMER Ø13
O 1200-0428	GUIDE HANDLE
O 1200-0429	WRENCH
O 1200-0430	CONNECTOR ROD
O 1200-0431	SCREW BOLT
O 1200-0432	REAMER Ø9
O 1200-0433	GUIDE WIRE
O 1200-0434	ALUMINIUM BOX

# O1200-0800 NEW FEMORAL RECONSTRUCTION INTRAMEDULLARY NAIL INSTRUMENT SET

O1200-0801	GUIDE WIRE
O1200-0802	FLEXIBLE REAMER
O1200-0803	CANNULATED REAMER Ø13,8 STOPPER
O1200-0804	FRACTURE ALIGNMENT DEVICE (T-TYPE)
O1200-0805	PROTECTION SKIN BOARD
O1200-0806	DISTAL POSITIONING FRAME
O1200-0807	LOCKING WHEELS M8X1 SW5 SMALL
O1200-0808	CANNULATED PUNCH DEVICE
O1200-0809	FLEXIBLE REAMER BIT Ø8,5-Ø13
O1200-0810	LOCKING WHEELS M8X1 SW5 LARGE
O1200-0811	LONG NAIL DISTAL GUIDE BAR 2
O1200-0812	LONG NAIL DISTAL CONNECTION GUIDE PIN
O1200-0813	LONG NAIL DISTAL GUIDE BAR
O1200-0814	AWL
O1200-0815	NAIL EXTRACTOR
O1200-0816	POSITIONING CARD
O1200-0817	T-HANDLE WITH QUICK COUPLING
O1200-0818	WRENCH SW3
O1200-0819	WRENCH SW5
O1200-0820	DRILL BIT Ø6,4 X 340 MM WITH STOPPER
O1200-0821	MEASURE DEVICE
O1200-0822	DEPTH GUIDE
O1200-0823	THREAD WIRE Ø2,5 X 320 MM
O1200-0824	KIRSCHNER WIRE Ø2,5 X 320 MM
O1200-0825	GUIDE PIN CONTROL DEVICE
O1200-0826	HANDLE
O1200-0827	NAIL LOCKING ROD
O1200-0828	SOFT TISSUE SEPERATION 138 MM
O1200-0829	T-HANDLE DRILL BIT Ø5.2MM FOR DISTAL ALIGNMENT DEVICE
O1200-0830	SOFT TISSUE SEPERATION 173 MM
O1200-0831	T-HANDLE DISTAL ALIGNMENT DEVICE
O1200-0832	DRILL BIT Ø4,3 X 300 MM
O1200-0833	DRILL BIT Ø4,3 X 300 MM WITH STOPPER
O1200-0834	T-HANDLE HEXAGONAL SCREW DRIVER SW 6,5
O1200-0835	CONNECTING SCREW UNIVERSAL SPANNER SW 6.5
O1200-0836	POSITIONING SLEEVE 120 MM
O1200-0837	T-HANDLE CANNULATED HEXAGONAL SCREW DRIVER SW 5,0
O1200-0838	POSITIONING SLEEVE 155 MM
O1200-0839	HEXAGONAL SCREW SHAFT SW5
O1200-0840	LIMIT DEVICE Ø6,4 MM
O1200-0841	LIMIT DEVICE Ø4,3 MM
O1200-0842	LIMIT DEVICE Ø2,5 MM
O1200-0843	LIMIT DEVICE Ø5,2 MM
O1200-0844	T-HANDLE HEXAGONAL SCREW DRIVER SW 3,5 MM
O1200-0845	DRILL BIT Ø5.2 X 248 MM
O1200-0846	HEXAGONAL SCREW SHAFT SW 3,5 MM
O1200-0847	ALUMINIUM BOX

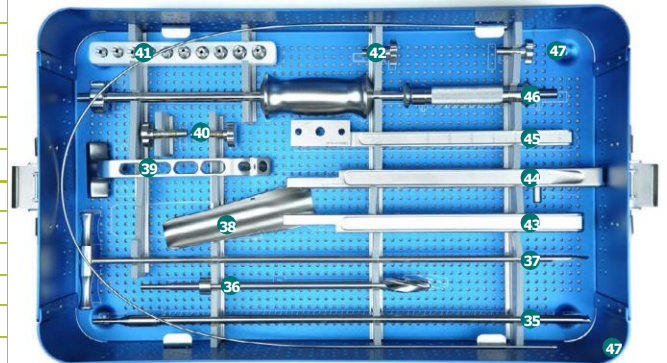
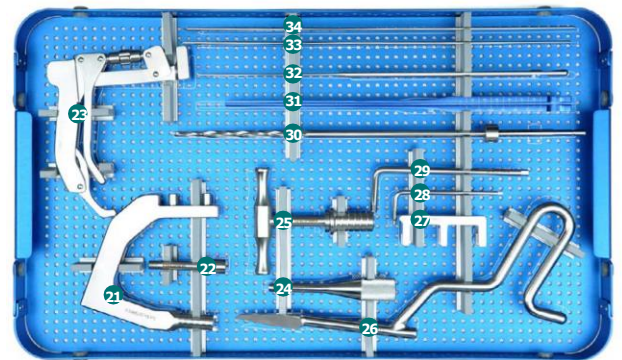
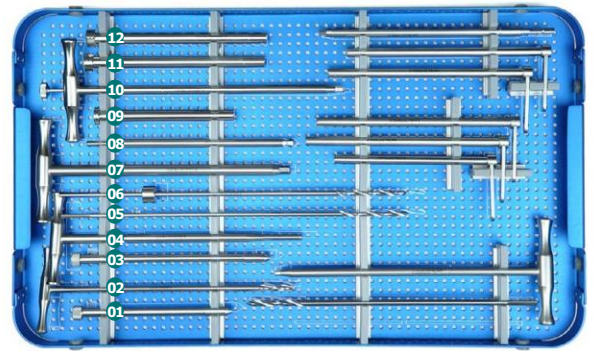

## O1200-0700 APFNA FEMUR SHORT NAIL INSTRUMENT SET

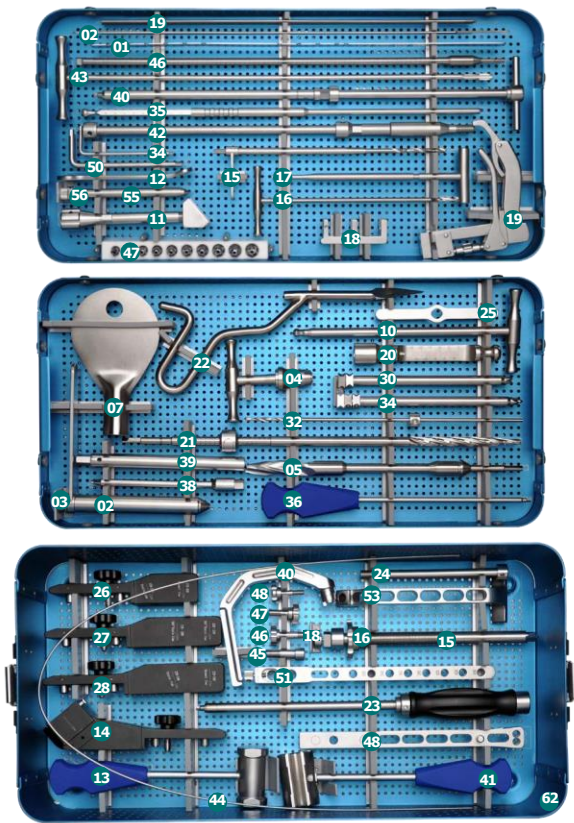

O1200-0701	TEMPLATE FOR DEVELOPMENT
O1200-0702	GUIDE SLEEVE Ø16,5
O1200-0703	GUIDE PIN SLEEVE Ø16,5/Ø3,2
O1200-0704	HANDLE WITH QUICK COUPLING
O1200-0705	PROXIMAL HOLLOW DRILL BIT Ø16,5/Ø3,2
O1200-0706	HOLLOW OPEN TAPPER
O1200-0707	PROTECTED PLATE FOR SOFT TISSUE
O1200-0708	HANDLE
O1200-0709	CONNECTING BOLT M10X1,5/SW8
O1200-0710	UNIVERSAL WRENCH OF CONNECTING BOLT SW8
O1200-0711	MAIN PIN IMPACTOR
O1200-0712	OPEN WRENCH SW11
O1200-0713	IMPACTOR HAMMER
O1200-0714	PROXIMAL GUIDE BAR
O1200-0715	GUIDE SLEEVE Ø11,2
O1200-0716	SUPPORT/COMPRESSION NUT
O1200-0717	GUIDE SLEEVE FOR PINS Ø11,2/Ø3,2
O1200-0718	PINS Ø3,2
O1200-0719	THREAD PIN Ø3,2X400 MM
O1200-0720	DEPTH GAUGE Ø3,2
O1200-0721	PROXIMAL HOLLOW POSITION STOPPER Ø10,6/Ø3,2
O1200-0722	POSITION STOPPER
O1200-0723	SCREWDRIVER M7*1 L/SW4,5/Ø3,2
O1200-0724	CONNECTOR
O1200-0725	WRENCH
O1200-0726	DISTAL GUIDE BAR 180
O1200-0727	DISTAL GUIDE BAR 240
O1200-0728	DISTAL 90 DEGREE GUIDE BAR 180/240
O1200-0729	DISTAL LOCKING PIN SLEEVE Ø11/Ø8,2
O1200-0730	SOFT TISSUE SEPERATING DEVICE Ø8,2/Ø4,3
O1200-0731	SLEEVE PIN Ø4,3
O1200-0732	DRILL BIT Ø4,3
O1200-0733	POSITION STOPPER Ø4,3/SW3
O1200-0734	SMALL WRENCH SW3/Ø4
O1200-0735	DISTAL LOCKING HOLES DEPTH GAUGE
O1200-0736	DISTAL LOCKING SCREW WRENCH SW 3,5
O1200-0737	TAIL HOOK GUIDE PIN Ø2,8
O1200-0738	TAIL HOLLOW SCREWDRIVER Ø2,8/SW6,5/SW11
O1200-0739	TAIL HOLLOW SLEEVE/EXTENSION ROD SW11
O1200-0740	BLADE NAIL DEVICE M7*1 L/SW4,5
O1200-0741	SLIDING HAMMER
O1200-0742	NAIL REMOVE ROD M10X1,5
O1200-0743	REDUCTION ROD (GUIDE PIN LEADING DEVICE)
O1200-0744	BALL HEAD GUIDE PIN Ø2,5/Ø4
O1200-0745	GUIDE PIN CONTROL DEVICE
O1200-0746	SOFT EXPANSION TOOL ROD Ø2,5/Ø8
O1200-0747	SOFT EXPANSION METALLUTGY Ø8-Ø13
O1200-0748	LONG NAIL DISTAL CONNECTION GUIDE PIN
O1200-0749	LONG NAIL DISTAL CONNECTION GUIDE BAR LOCK WHEELS M8X1/SW5
O1200-0750	LOCKING WHEEL SPANNER
O1200-0751	LONG NAIL DISTAL GUIDE BAR
O1200-0752	LONG NAIL DISTAL GUIDE PIN LOCKING WHEELS M8X1/SW5
O1200-0753	LONG NAIL DISTAL POSITIONING FRAME
O1200-0754	LONG NAIL DISTAL POSITIONING FRAME LOCK WHEELS M6/SW5
O1200-0755	POSITIONING PIPE Ø10/Ø8,1
O1200-0756	POSITIONING STEM BUSHING NEEDLE Ø8,1
O1200-0757	POSITIONING STEM DRILLING SHEATH Ø8,1/Ø5,2
O1200-0758	POSITIONING DRILL ROD Ø5,2
O1200-0759	POSITIONING STEM FLATS DRILL Ø5,2
O1200-0760	POSITIONING ROD Ø8,1/Ø5,2
O1200-0761	POSITIONING CARD
O1200-0762	ALUMINIUM BOX



## O1200-0900 ANT TIBIAL INTRAMEDULLARY NAIL INSTRUMENT SET

O1200-0901	HEXAGONAL SCREW HOLDER SW 3,5
O1200-0902	T-HANDLE CONNECTING ROD UNIVERSAL DRIVER SW6.5
O1200-0903	T-HANDLE HEXAGONAL SCREW DRIVER SW 3.5
O1200-0904	HEXAGONAL SCREW DRIVER SHAFT SW 3.5
O1200-0905	RULER FOR PERFECT TIBIAL NAIL
O1200-0906	FRACTURE ALIGNMENT DEVICE (T-TYPE)
O1200-0907	T-HANDLE DRILL BIT Ø5.2MM FOR DISTAL ALIGNMENT DEVICE
O1200-0908	DISTAL ALIGNMENT DEVICE (T-HANDLE)
O1200-0909	DEPTH GAUGE
O1200-0910	PROTECTION SLEEVE WITH 3.2 DRILL SLEEVE & TROCER PIN
O1200-0911	SOFT TISSUE SEPERATOR
O1200-0912	DRILL SLEEVE 8.0 X 5.2 MM
O1200-0913	DRILL SLEEVE 8.0 X 4.0 MM
O1200-0914	DRILL STOPPER KEY SW 3,0
O1200-0915	FRAME RODS LOCKING KEY SW 5,0
O1200-0916	SMALL WRENCH
O1200-0917	COMBINATION WRENCH
O1200-0918	PROTECTION SLEEVE Ø 12
O1200-0919	REAMER SHAFT
O1200-0920	DRILL STOPPER Ø 4.0
O1200-0921	DRILL BIT Ø 4.0
O1200-0922	CANNULATED DRILL BIT Ø12
O1200-0923	THREADED GUIDE WIRE Ø3X300
O1200-0924	DRILL STOPPER Ø 3,2
O1200-0925	DRILL BIT Ø 5.2
O1200-0926	SKIN PROTECTOR
O1200-0927	COMPRESSION BOLT
O1200-0928	CONNECTING SCREW CANNULATED
O1200-0929	T-HANDLE QUICK COUPLING
O1200-0930	T-HANDLE CONNECTING ROD SCREWDRIVER SW 6.5
O1200-0931	CONNECTOR FOR INSERTION HANDLE
O1200-0932	PROTECTION SLEEVE 8.1 ID X 10 OD - 1
O1200-0933	PROTECTION SLEEVE 8.1 ID X 10 OD - 2
O1200-0934	CANNULATED AWL
O1200-0935	PROXIMAL AIMING ARM-ANGULAR
O1200-0936	PROXIMAL AIMING ARM
O1200-0937	DISTAL AIMING ARM
O1200-0938	SLIDING HAMMER GUIDE ROD
O1200-0939	CONNECTING PART OF DISTAL AIMING ARM
O1200-0940	CONNECTING BOLT Ø 6.0
O1200-0941	DISTAL JIG GUIDE
O1200-0942	NAIL EXTRACTOR
O1200-0943	GUIDE WIRE HOLDER
O1200-0944	INSERTION HANDLE
O1200-0945	CONNECTING BOLT Ø 8.0
O1200-0946	POSITIONING BLOCK FOR DISTAL ALIGNMENT DEVICE
O1200-0947	CANNULATED CUTTER FOR PERFECT TIBIAL NAIL Ø 12
O1200-0948	SLIDING HAMMER
O1200-0949	REAMER HEAD
O1200-0950	GUIDE WIRE
O1200-0951	ALUMINIUM CASE & TRAYS

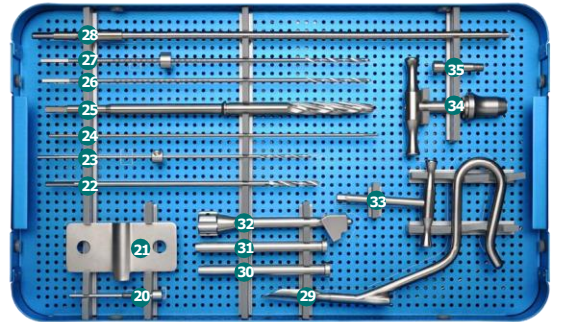
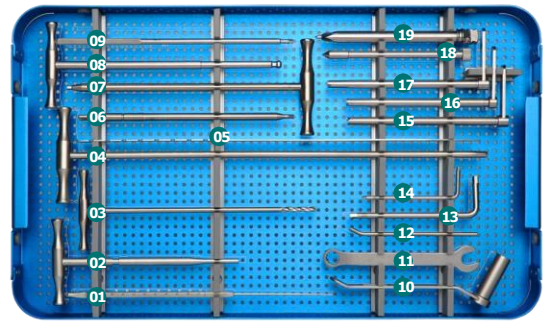

## O1200-0200 TIBIAL INTRAMEDULLARY NAIL INSTRUMENT SET

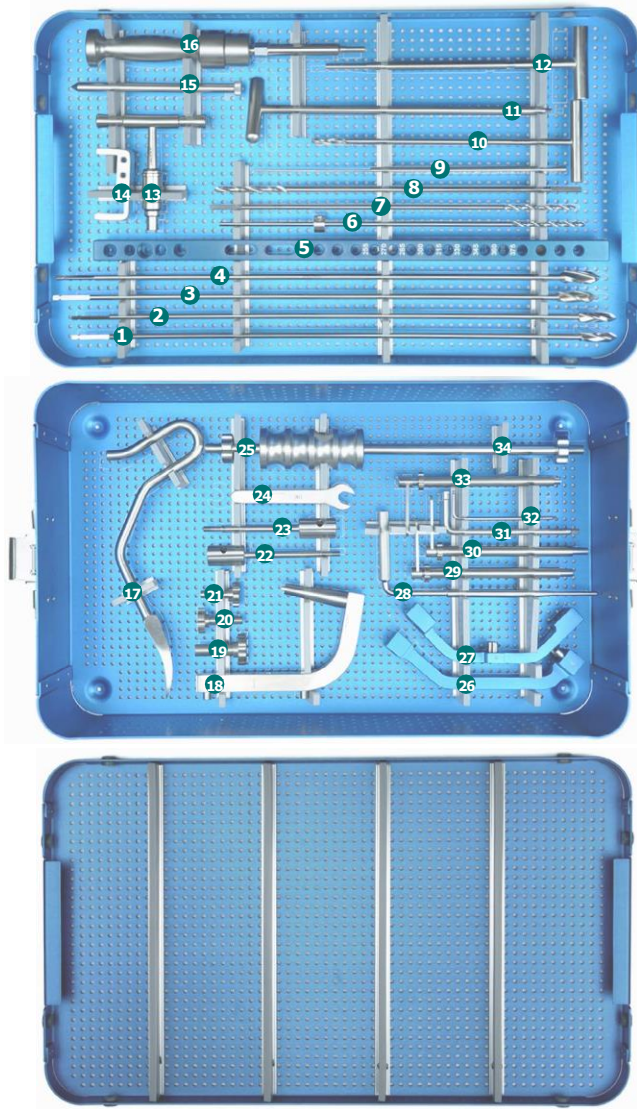

O1200-0201	UNIVERSAL JOINT
O1200-0202	SOFT TISSUE SEPERATOR
O1200-0203	QUICK COUPLING T-HANDLE
O1200-0204	FIXED CONNECTOR
O1200-0205	LOCATION ROD
O1200-0206	SCREWDRIVER
O1200-0207	T-HANDLE DRILL BIT 5,2 MM
O1200-0208	DEPTH GAUGE 10-100 MM
O1200-0209	DRILL BIT 5,2X300 MM
O1200-0210	DRILL BIT 4,0X300 MM
O1200-0211	DRILL BIT WITH LIMITATOR 4,0X300 MM
O1200-0212	GUIDE ROD
O1200-0213	REAMER 13 MM
O1200-0214	REAMER 12 MM
O1200-0215	REAMER 11 MM
O1200-0216	REAMER 10 MM
O1200-0217	REAMER 9 MM
O1200-0218	REAMER 8 MM
O1200-0219	DISTAL GUIDE
O1200-0220	SIGHTING DEVICE HANDLE
O1200-0221	PROXIMAL GUIDE
O1200-0222	AWL
O1200-0223	LOCATION FORCEPS
O1200-0224	DRILL SLEEVE 4,2-10 MM
O1200-0224	DRILL SLEEVE 4,2-10 MM
O1200-0225	HEXAGONAL WRENCH HEX 5,0 MM
O1200-0226	HEXAGONAL WRENCH HEX 3,0 MM
O1200-0227	DRILL SLEEVE 5,4-10 MM
O1200-0228	BOLT M12X1
O1200-0229	BOLT M8X1 LONG
O1200-0230	BOLT M8X1
O1200-0231	NAIL CONNECTOR SOLID
O1200-0232	NAIL CONNECTOR CANNULATED
O1200-0233	OPEN WRENCH
O1200-0234	HAMMER
O1200-0235	GUIDE WIRE
O1200-0236	ALUMINIUM BOX

## O5200-0100 AYFIX EXTERNAL FIXATOR INSTRUMENT SET

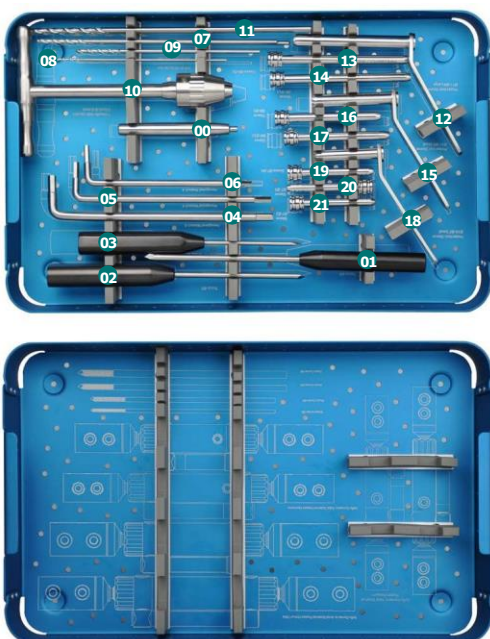

O5200-0101	TROCAR
O5200-0102	HEXAGONAL WRENCH 6.0 MM
O5200-0103	HEXAGONAL WRENCH 4.0 MM
O5200-0104	HEXAGONAL WRENCH 5.0 MM
O5200-0105	SLEEVE GUIDE
O5200-0106	DRILL GUIDE
O5200-0107	DRILL GUIDE AND SLEEVE GUIDE
O5200-0108	T-WRENCH (QUICK COUPLING DRILL)
O5200-0109	WRENCH
O5200-0110	T-HANDLE WITH JACOB'S CHUCK
O5200-0111	T-HANDLE SHAFT
O5200-0112	T-HANDLE ADAPTER 4.0 /5.0/6.0 MM
O5200-0113	TWO SIDE OPEN WRENCH
O5200-0114	SINGLE SIDE OPEN WRENCH
O5200-0115	ONE SIDE OPEN ONE SIDE CIRCULAR WRENCH
O5200-0116	DRILL BIT WITH STOPPER
O5200-0117	LONG BONE DRILL
O5200-0118	ALUMINIUM BOX

## O1200-1200 INTRAMEDULLARY NAIL REMOVAL INSTRUMENT SET

O1200-1201	END CUP WRENCH 180 MM
O1200-1202	WRENCH
O1200-1203	WIRE CUTTER
O1200-1204	OPEN WRENCH
O1200-1205	HEXAGONAL SCREWDRIVER SW 4,5
O1200-1206	HEXAGONAL SCREWDRIVER SW 5,0
O1200-1207	LOCKING SCREW EXTRACTOR 250 MM
O1200-1208	HEXAGONAL SCREWDRIVER SW 2,5
O1200-1209	HEXAGONAL SCREWDRIVER SW 3,5
O1200-1210	HEXAGONAL SCREWDRIVER SW 4,0
O1200-1211	T-HANDLE WITH QUICK COUPLING
O1200-1212	EXTRACTOR CHUCK UNIVERSAL LARGE
O1200-1213	EXTRACTOR CHUCK M6
O1200-1214	EXTRACTOR CHUCK SW 4,0
O1200-1215	EXTRACTOR CHUCK SW 4,5
O1200-1216	EXTRACTOR CHUCK M10X1
O1200-1217	EXTRACTOR CHUCK M8X1
O1200-1218	EXTRACTOR CHUCK M8
O1200-1219	EXTRACTOR CHUCK UNIVERSAL SMALL
O1200-1220	EXTRACTOR CHUCK M11
O1200-1221	EXTRACTOR CHUCK M10
O1200-1222	SAW BLADE SCREWDRIVER
O1200-1223	HAMMER
O1200-1224	UNIVERSAL JOINT
O1200-1225	ALUMINIUM CASE & TRAYS

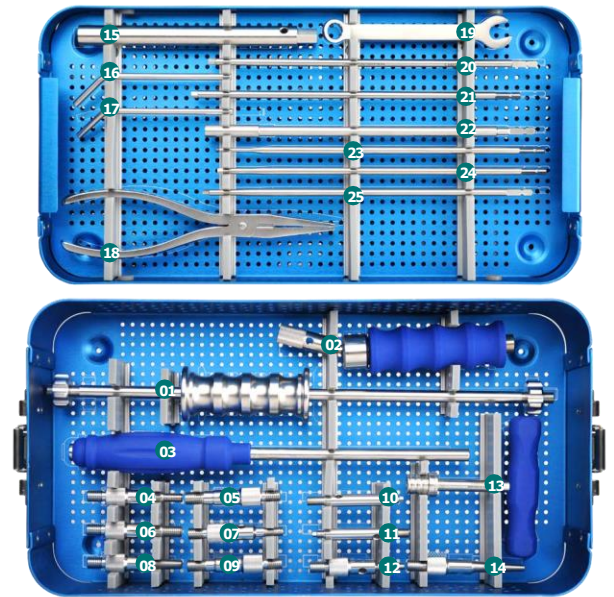

## O1200-0600 ELASTIC NAIL INSTRUMENT SET

O1200-0601	HAMMER
O1200-0602	AWL
O1200-0603	EXTRACTION PLIERS
O1200-0604	DOUBLE DRILL SLEEVE Ø3,2-4,5 MM
O1200-0605	END CAP INSERTER LARGE
O1200-0606	END CAP INSERTER SMALL
O1200-0607	NAIL INSERTER
O1200-0608	DRILL BIT 2,7X130 MM
O1200-0609	DRILL BIT 3,2X150 MM
O1200-0610	DRILL BIT 4,5X190 MM
O1200-0611	BENDER 140°
O1200-0612	BENDER 130°
O1200-0613	STANDART TAMP
O1200-0614	BEVELED TAMP
O1200-0615	CUTTER
O1200-0616	HAMMER GUIDE
O1200-0617	KEY OF CUTTER
O1200-0618	ALUMINIUM BOX

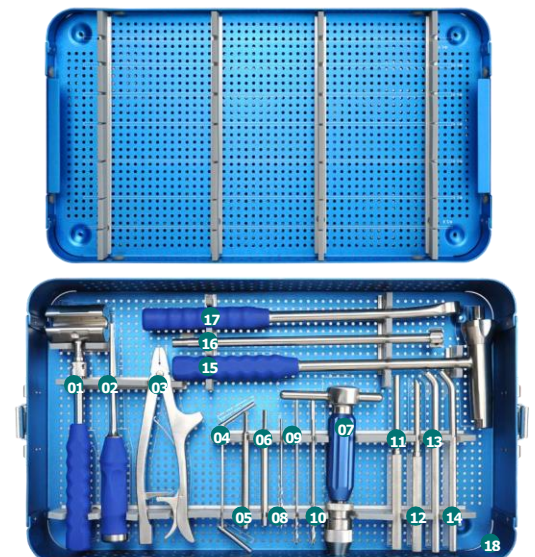

## O2200-0100 SPINAL PEDICLE SCREW SYSTEM INSTRUMENT SET

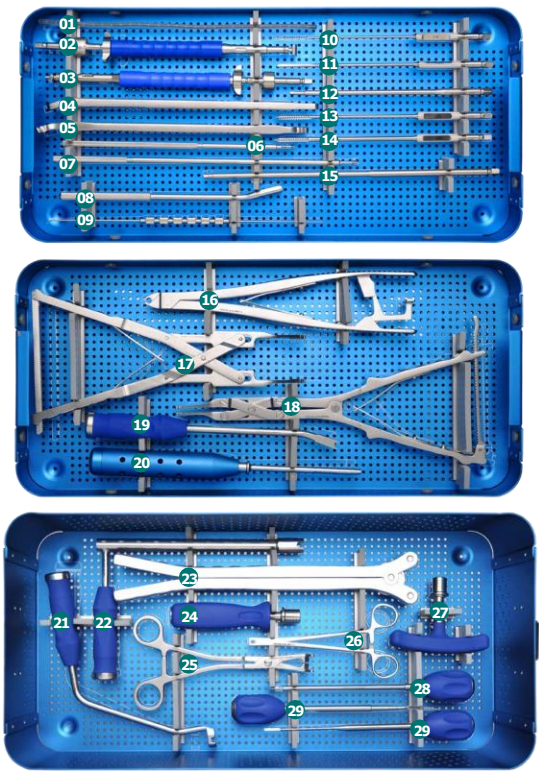

O2200-0101	FEELER FOR SCREW CHANNEL STRAIGHT
O2200-0102	HEXAGONAL SCREWDRIVER FOR SREW NUT
O2200-0103	TAP Ø4,0
O2200-0104	TAP Ø5,0
O2200-0105	SCREWDRIVER HEXAGONAL 3,5 MM FOR
O2200-0106	TAP Ø6,0
O2200-0107	TAP Ø7,0
O2200-0108	FEELER FOR SCREW CHANNEL BENT
O2200-0109	SCREW CUTTER FOR LONGARM SCREW
O2200-0110	SCREW NUT HOLDER HEXAGONAL
O2200-0111	CROSSLINK NUT HOLDER HEXAGONAL
O2200-0112	IN-SITU BENDING IRON
O2200-0113	SCREWDRIVER FOR POLYAXIAL SCREW
O2200-0114	SCREWDRIVER FOR MONOAXIAL SCREW
O2200-0115	TRAIL ROD
O2200-0116	INSERT DEVICE FOR FIXATION PIN
O2200-0117	ROD PUSHERIAL
O2200-0118	PARALLEL SPREADER
O2200-0119	PARALLEL COMPRESSOR
O2200-0120	ROD TWIST
O2200-0121	PEDICLE PROBE STRAIGHT
O2200-0122	PEDICLE PROBE BENT
O2200-0123	AWL
O2200-0124	T-HANDLE QUICK COUPLING
O2200-0125	ROD HOLDING FORCEPS
O2200-0126	ROD BENDER
O2200-0127	COUNTER TORQUE FOR CUTTER
O2200-0128	ROD PUSHING FORCEPS
O2200-0129	STRAIGHT HANDLE QUICK COUPLING
O2200-0130	COUNTER TORQUE
O2200-0131	ALUMINIUM BOX

## O2200-0200 ANTERIOR CERVICAL PLATE SYSTEM INSTRUMENT SET

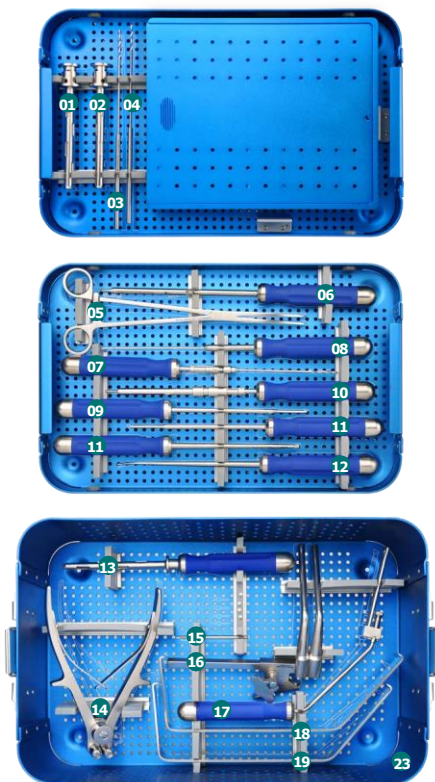

O2200-0201	SCREWDRIVER SLEEVE
O2200-0202	SCREWDRIVER SLEEVE
O2200-0203	DRILL BIT
O2200-0204	DRILL BIT
O2200-0205	PLATE AND SCREW BOX
O2200-0206	CURETTE
O2200-0207	HEXAGONAL SCREWDRIVER
O2200-0208	BRACE SCREWDRIVER
O2200-0209	AWL
O2200-0210	TAP
O2200-0211	NUT SCREWDRIVER
O2200-0212	HEXAGONAL SCREWDRIVER
O2200-0213	HEXAGONAL SCREWDRIVER
O2200-0214	PLATE HOLDING FORCEPS
O2200-0215	CERVICAL HOOK
O2200-0216	CERVICAL HOOK
O2200-0217	GUIDE
O2200-0218	DISTRACTOR
O2200-0219	BRACE SCREW
O2200-0220	LOCATION SCREW
O2200-0221	PLATE BENDER
O2200-0222	LOCATION SCREW SCREWDRIVER
O2200-0223	ALUMINIUM BOX

## O2200-0300 POSTERIOR CERVICAL FIXATION SYSTEM INSTRUMENT SET

O2200-0301	DEPTH GAUGE 4-40 MM
O2200-0302	DRILL BIT 2,7 MM
O2200-0303	DRILL BIT 2,4 MM
O2200-0304	TRAIL ROD
O2200-0305	SCREWDRIVER HEXAGONAL 2,5 MM
O2200-0306	TAP Ø4,0
O2200-0307	TAP Ø3,5
O2200-0308	NUT HOLDER
O2200-0309	FEELER FOR SCREW CHANNEL BENT
O2200-0310	FEELER FOR SCREW CHANNEL STRAIGHT
O2200-0311	DISTRACTOR
O2200-0312	IN-SITU BENDING IRON L
O2200-0313	IN-SITU BENDING IRON R
O2200-0314	T-HANDLE QUICK COUPLING
O2200-0315	HOOK HOLDING FORCEPS
O2200-0316	ROD HOLDING FORCEPS
O2200-0317	GUIDE
O2200-0318	SCREWDRIVER HEXAGONAL 2,5 MM
O2200-0319	ROD PUSHING FORCEPS
O2200-0320	STRAIGHT HANDLE QUICK COUPLING
O2200-0321	INSERT DEVICE FOR FIXATION PIN
O2200-0322	COUNTER TORQUE
O2200-0323	SCREWDRIVER FOR POLYAXIAL SCREW
O2200-0324	ROD BENDER
O2200-0325	AWL
O2200-0326	AWL
O2200-0327	PROTECTION SLEEVE
O2200-0328	DISTRACTION FORCEPS
O2200-0329	ROD CUTTER
O2200-0330	PARALLEL COMPRESSION FORCEPS
O2200-0331	ROD TWIST
O2200-0332	ALUMINIUM BOX

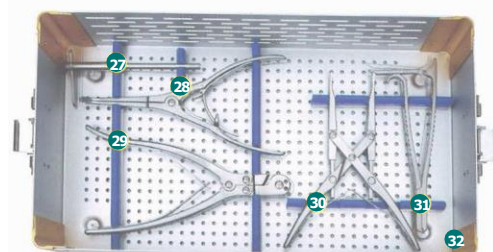
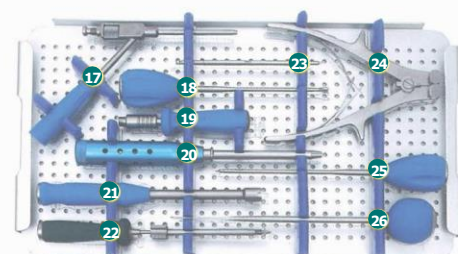
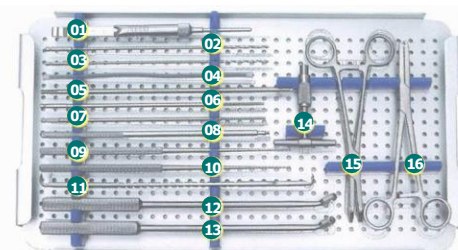

## O2200-0400 ANTERIOR THORACIC & LUMBAR PLATE SYSTEM INSTRUMENT SET

O2200-0401	CURVED GUIDE PIN
O2200-0402	STRAIGHT GUIDE PIN
O2200-0403	DRILL BIT
O2200-0404	OBTURATOR
O2200-0405	NUT DRIVER SW8
O2200-0406	NUT DRIVER SW8
O2200-0407	DRILL GUIDE
O2200-0408	DETECTOR
O2200-0409	HOLE ENLARGER
O2200-0410	TAP 6,5 MM
O2200-0411	SCREW HOLDING DRIVER
O2200-0412	TAP 6 MM
O2200-0413	SCREWDRIVER
O2200-0414	UNIVERSAL SCREWDRIVER
O2200-0415	SCREWDRIVER
O2200-0416	CALIPERS
O2200-0417	COMPRESSION CLAMP 3 MM
O2200-0418	DISTRACTOR CLAMP
O2200-0419	PLATE HOLDING CLAMP
O2200-0420	HOLDING BOLT SW8
O2200-0421	COMBINATION WRENCH
O2200-0422	WRENCH SW11
O2200-0423	ALUMINIUM BOX

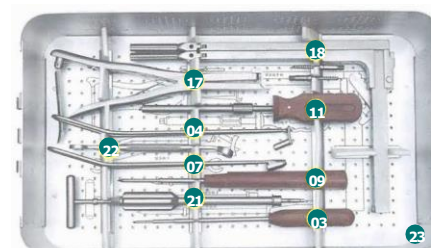
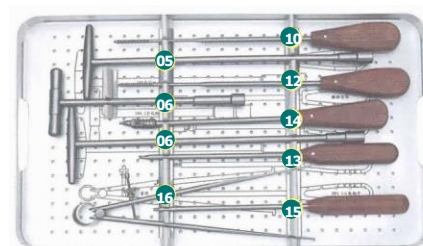
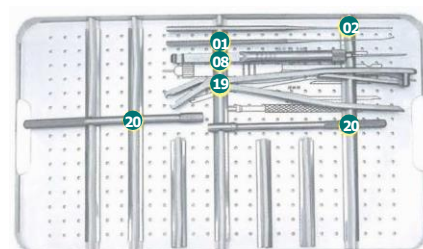

## O4200-1000 SCREW REMOVAL INSTRUMENT SET

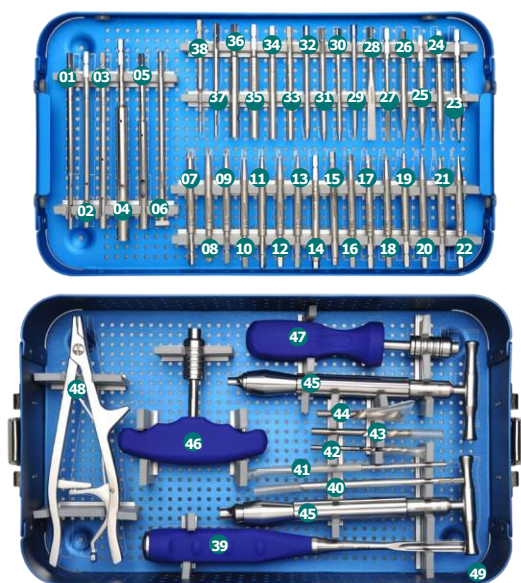

O4200-1000	SCREW REMOVAL INSTRUMENT SET
O4200-1001	HOLLOW REAMER Ø4,0
O4200-1002	HOLLOW REAMER Ø5,0
O4200-1003	HOLLOW REAMER Ø6,5
O4200-1004	HOLLOW REAMER Ø8,0
O4200-1005	HOLLOW REAMER Ø10
O4200-1006	SPINAL MONOAXIAL PEDICLE SCREWDRIVER
O4200-1007	TORX SCREWDRIVER Ø5,3
O4200-1008	TORX SCREWDRIVER Ø4,3
O4200-1009	TORX SCREWDRIVER Ø3,8
O4200-1010	TORX SCREWDRIVER Ø3,4
O4200-1011	TORX SCREWDRIVER Ø3,2
O4200-1012	TORX SCREWDRIVER Ø2,7
O4200-1013	TORX SCREWDRIVER Ø2,3
O4200-1014	HEXAGONAL SCREWDRIVER SW 5,5
O4200-1015	HEXAGONAL SCREWDRIVER SW 5,0
O4200-1016	HEXAGONAL SCREWDRIVER SW 4,5
O4200-1017	HEXAGONAL SCREWDRIVER SW 4,0
O4200-1018	HEXAGONAL SCREWDRIVER SW 3,5
O4200-1019	HEXAGONAL SCREWDRIVER SW 3,0
O4200-1020	HEXAGONAL SCREWDRIVER SW 2,5
O4200-1021	HEXAGONAL SCREWDRIVER SW 2,0
O4200-1022	HEXAGONAL SCREWDRIVER SW 1,5
O4200-1023	SQUARE SCREWDRIVER SW 1,5
O4200-1024	SQUARE SCREWDRIVER SW 1,2
O4200-1025	SQUARE SCREWDRIVER SW 1,1
O4200-1026	PHILLIPS SCREWDRIVER
O4200-1027	SLOTTED SCREWDRIVER LARGE
O4200-1028	SLOTTED SCREWDRIVER SMALL
O4200-1029	EXTRACTION SCREW HEXAGONAL 2,5X0,5 MM CONICAL
O4200-1030	EXTRACTION SCREW HEXAGONAL 2,5 MM CONICAL
O4200-1031	EXTRACTION SCREW HEXAGONAL 3,5 MM CONICAL
O4200-1032	EXTRACTION SCREW HEXAGONAL 4,0 MM CONICAL
O4200-1033	EXTRACTION BOLT Ø3,5
O4200-1034	EXTRACTION BOLT Ø4,5
O4200-1035	EXTRACTION BOLT Ø6,0
O4200-1036	EXTRACTION BOLT Ø6,5
O4200-1037	HOLLOW REAMER Ø3,0
O4200-1038	HOLLOW REAMER Ø2,7
O4200-1039	ROUND GAUGE 8 MM
O4200-1040	TIP SCREWDRIVER
O4200-1041	SHARP HOOK
O4200-1042	HIGH SPEED DRILL BIT Ø4,0X80
O4200-1043	HIGH SPEED DRILL BIT Ø6,0X80
O4200-1044	HIGH SPEED DRILL BIT Ø8,0X80
O4200-1045	SCREW EXTRACTOR
O4200-1046	I-HANDLE WITH QUICK COUPLING
O4200-1047	T-HANDLE WITH QUICK COUPLING
O4200-1048	PLIERS FOR SCREW REMOVAL
O4200-1049	ALUMINIUM BOX



## 05200-0300 TUBULAR EXTERNAL FIXATOR INSTRUMENT SET SMALL

O5200-1300	TUBULAR EXTERNAL FIXATOR INSTRUMENT SET
O600 11 006 0001	TUBULAR FIXATOR ROD-ROD CLAMP 5 MM
O600 11 006 0002	TUBULAR FIXATOR ROD-PIN CLAMP 5 MM
O600 11 006 0003	TUBULAR FIXATOR MULTIPLE PIN CLAMP 5 MM
O600 11 006 0004	TUBULAR FIXATOR MULTIPLE PIN T CLAMP 5 MM
O600 29 121 0120	TUBULAR FIXATOR 30° ANGLED SUPPORT 5 MM
O600 11 005 0004	TUBULAR FIXATOR STRAIGHT SUPPORT 5 MM
O101 03 090 2712	MATKAP UCU (DRILL) 2,7 X 130 MM
O101 03 090 2212	MATKAP UCU (DRILL) 2,2 X 100 MM
O101 03 090 0020	MATKAP UCU (DRILL) 1,7 X 80 MM
O100 03 090 6030	SCHANZ VIDASI (SCHANZ SCREW) 3,5 X 130 MM
O100 03 090 3115	SCHANZ VIDASI (SCHANZ SCREW) 3,0 X 100 MM
O100 03 091 6020	SCHANZ VIDASI (SCHANZ SCREW) 2,5 X 80 MM
O600 11 005 0050	TUBULAR FIXATOR ROD CARBON 5 X 50 MM
O600 11 005 0100	TUBULAR FIXATOR ROD CARBON 5 X 100 MM
O600 11 005 0150	TUBULAR FIXATOR ROD CARBON 5 X 200 MM
O600 11 005 0250	TUBULAR FIXATOR ROD CARBON 5 X 250 MM
O5200-1317	Ø2,7 MM DRILL SLEEVE
O5200-1318	Ø2,2 MM DRILL SLEEVE
O5200-1319	Ø1,7 MM DRILL SLEEVE
O5200-1320	Ø3,5 MM SCHANZ SLEEVE
O5200-1321	Ø3,0 MM SCHANZ SLEEVE
O5200-1322	Ø2,5 MM SCHANZ SLEEVE
O5200-1323	PROTECTION SLEEVE
O5200-1324	TROCHAR
O550 01 091 0633	T-HANDLE WITH JACOB'S CHUCK ( 0-6,0 MM)
O5200-1326	WRENCH
O5200-1327	HEXAGONAL WRENCH 4 MM
O5200-1318	ALUMINUM BOX

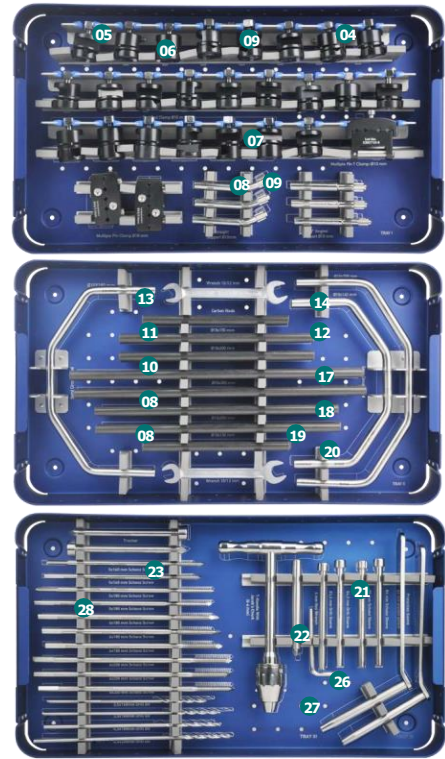

## 05200-2300 TUBULAR EXTERNAL FIXATOR INSTRUMENT SET MEDIUM

<b>O5200-2300</b>	<b>TUBULAR EXTERNAL FIXATOR INSTRUMENT SET)-MEDIUM</b>
O600 11 014 0001	TUBULAR FIXATOR ROD-ROD CLAMP 8 MM
O600 11 014 0002	TUBULAR FIXATOR ROD-PIN CLAMP 8 MM
O600 11 014 0003	TUBULAR FIXATOR MULTIPLE PIN CLAMP 8 MM
O600 11 014 0004	TUBULAR FIXATOR MULTIPLE PIN T CLAMP 8 MM
O600 29 121 0080	TUBULAR FIXATOR 30° ANGLED SUPPORT 8 MM
O600 11 008 0004	TUBULAR FIXATOR STRAIGHT SUPPORT 8 MM
O101 03 090 3212	DRILL 3,2 MM
O101 03 090 0045	DRILL 3,7 MM
O101 03 090 0045	DRILL 3,7 MM
O100 03 090 4011	SCHANZ SCREW Ø4,0 MM
O100 03 090 4517	SCHANZ SCREW 4,5 MM
O100 03 090 5013	SCHANZ SCREW 5,0 MM
O100 03 090 5013	SCHANZ SCREW 5,0 MM
O600 11 008 0100	TUBULAR FIXATOR ROD CARBON 8 X 100 MM
O600 11 008 0150	TUBULAR FIXATOR ROD CARBON 8 X 180 MM
O600 11 008 0200	TUBULAR FIXATOR ROD CARBON 8 X 200 MM
O600 11 008 0250	TUBULAR FIXATOR ROD CARBON) 8 X 250 MM
O600 10 151 0160	TUBULAR FIXATOR SEMI CIRCULAR ROD 8 X 160 MM
O600 10 151 0180	TUBULAR FIXATOR SEMI CIRCULAR ROD 8 X 180 MM
O600 10 151 0200	TUBULAR FIXATOR SEMI CIRCULAR ROD 8 X 200 MM
O5200-2301	Ø3,2 MM DRILL SLEEVE
O5200-2302	Ø3,7 MM DRILL SLEEVE
O5200-2303	Ø4,0 MM SCHANZ SLEEVE
O5200-2304	Ø4,5 MM SCHANZ SLEEVE
O5200-2305	Ø5,0 MM SCHANZ SLEEVE
O5200-2306	PROTECTION SLEEVE
O5200-2307	TROCHAR
O5200-2308	T-HANDLE WITH JACOB'S CHUK ( 0-6,0 MM)
O5200-3309	HEXAGONAL WRENCH (4 MM)
O5200-2310	WRENCH
O5200-2311	ALUMINUM BOX

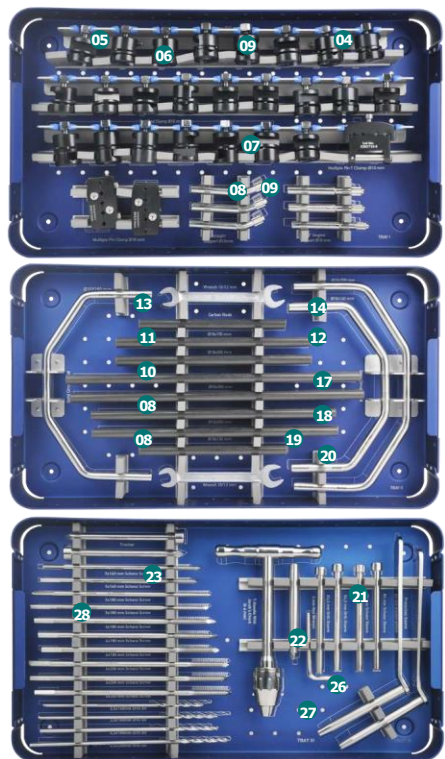

## 05200-3300 TUBULAR EXTERNAL FIXATOR INSTRUMENT SET LARGE

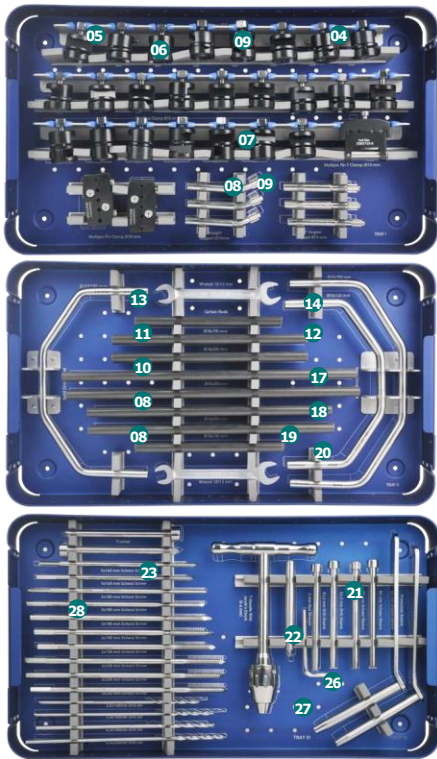

05200-3300	TUBULAR EXTERNAL FIXATOR INSTRUMENT SET)-LARGE
O600 11 010 0001	TUBULAR FIXATOR ROD-ROD CLAMP 10 MM
O600 11 010 0002	TUBULAR FIXATOR ROD-PIN CLAMP 10 MM
O600 11 010 0003	TUBULAR FIXATOR MULTIPLE PIN CLAMP 10 MM
O600 11 010 0004	TUBULAR FIXATOR MULTIPLE PIN T CLAMP 10 MM
O600 29 121 0100	TUBULAR FIXATOR 30° ANGLED SUPPORT 10 MM
O600 11 010 0007	TUBULAR FIXATOR STRAIGHT SUPPORT 10 MM
O101 03 090 0045	MATKAP UCU (DRILL) 3,7 X 160 MM
O101 03 090 0045	MATKAP UCU (DRILL) 3,7 X 180 MM
O101 03 090 4512	MATKAP UCU (DRILL) 4,8 X 180 MM
O101 03 090 4512	MATKAP UCU (DRILL) 4,8 X 200 MM
O100 03 090 5515	SCHANZ VIDASI (SCHANZ SCREW) 5,0 X 160 MM
O100 03 090 5515	SCHANZ VIDASI (SCHANZ SCREW) 5,0 X 180 MM
O100 03 090 6012	SCHANZ VIDASI (SCHANZ SCREW) 6,0 X 180 MM
O100 03 090 6012	SCHANZ VIDASI (SCHANZ SCREW) 6,0 X 200 MM
O600 11 010 0150	TUBULAR FIXATOR ROD CARBON 10 X 150 MM
O600 11 010 0200	TUBULAR FIXATOR ROD CARBON 10 X 200 MM
O600 11 010 0250	TUBULAR FIXATOR ROD CARBON 10 X 250 MM
O600 11 010 0300	TUBULAR FIXATOR ROD CARBON 10 X 300 MM
O600 10 121 0160	TUBULAR FIXATOR SEMI CIRCULAR ROD 10 X 160 MM
O600 10 121 0180	TUBULAR FIXATOR SEMI CIRCULAR ROD 10 X 180 MM
O600 10 121 0200	TUBULAR FIXATOR SEMI CIRCULAR ROD 10 X 200 MM
O5200-3301	Ø3,7 MM DRILL SLEEVE
O5200-3302	Ø4,8 MM DRILL SLEEVE
O5200-3303	Ø5 MM SCHANZ SLEEVE
O5200-3304	Ø6 MM SCHANZ SLEEVE
O5200-3305	PROTECTION SLEEVE
O5200-3306	TROCHAR
O5200-3307	T-HANDLE WITH JACOB'S CHUCK ( 0-6,0 MM)
O5200-3310	HEXAGONAL WRENCH (4 MM)
O5200-3308	WRENCH
O5200-3309	ALUMINUM BOX

## 05200-0400 HYBRID EXTERNAL FIXATOR INSTRUMENT SET

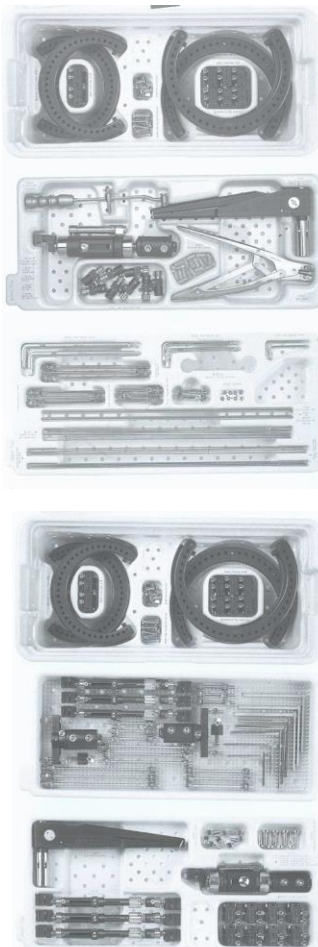

O 5200-0401	2X30017TWO-HOLE X-WIRE SECURING PIN THREE-HOLE WIRE CLAMP
O 5200-0402	SLIDER UNIT
O 5200-0403	WIRE GUIDE WIRE TENSIONER
O 5200-0404	HYBRID FIXATOR STANDARD ASSEMBLY KIT
O 5200-0405	CONSISTING OF: 7 PROCALLUS STANDARD CENTRAL BODY,
O 5200-0406	COMPRESSION-DISTRACTION UNIT STANDARD; 7 PROCALLUS STRAIGHT CLAMP;
O 5200-0407	HYBRID COUPLING WITH BALL-JOINT WIRE CUTTER
O 5200-0408	SUPPLEMENTARY SCREW HOLDER CLAMP
O 5200-0409	X-WIRE COVERS (PACK OF 20)
O 5200-0410	ALLEN WRENCH 6 MM ALLEN WRENCH 5 MM
O 5200-0411	RADIO LUCENT RINGS (SEE P. 36)
O 5200-0412	LOWER TRAY (GENERIC)
O 5200-0413	2X80035 SHEFFIELD CLAMP
O 5200-0414	2X80074 SINGLE SCREW CLAMP
O 5200-0415	3X80047 REDUCTION UNIT
O 5200-0416	3X11137 SCREW GUIDE, LENGTH 80 MM
O 5200-0417	3X 11103 SCREW GUIDE, LENGTH 100 MM
O 5200-0418	1X 11105 DRILL GUIDE 0.48 MM, LENGTH 80 MM
O 5200-0419	1X 11138 DRILL GUIDE 0.48 MM, LENGTH 60 MM
O 5200-0420	1X80034 BOLTS 60 MM (SET OF 3)
O 5200-0421	1X80036 THREADED BARS, LENGTH 80 MM (SET OF 3)
O 5200-0422	1X80037 THREADED BARS, LENGTH 120 MM (SET OF 3)
O 5200-0423	1X80038 THREADED BARS, LENGTH 160 MM (SET OF 3)
O 5200-0424	1X80039 THREADED BARS, LENGTH 200 MM (SET OF 3) UPPER TRAY
O 5200-0425	ALLEN WRENCH 3 MM INDEPENDENT WIRE CLAMP POST, LENGTH 50 MM
O 5200-0426	POST, LENGTH 100 MM POST, LENGTH 150 MM
O 5200-0427	F.F.S. LARGE WASHERS (PACK OF 4) SUPPLEMENTARY SCREW
O 5200-0428	HOLDER BAR 0.6 MM,
O 5200-0429	WIRE TENSIONER
O 5200-0430	RING LOCKING SCREW
O 5200-0431	TWO-HOLE X-WIRE SECURING PIN HYBRID FIXATOR SHORT ASSEMBLY KIT
O 5200-0432	CONSISTING OF: 7 PROCALLUS STRAIGHT CLAMP,
O 5200-0433	PROCALLUS SHORT CENTRAL BODY, 7 COMPRESSION
O 5200-0434	SUPPLEMENTARY SCREW HOLDER BAR 0.6 MM, LENGTH 400 MM X-WIRE WITH LATERAL OLIVE
O 5200-0435	2 MM, LENGTH 400 MM X-WIRE WITH CENTRAL OLIVE 0.2 MM, LENGTH 400 MM X-WIRE WITH CENTRAL OLIVE 0.2 MM, LENGTH 450 MM X-WIRE WITHOUT OLIVE
O 5200-0436	2 MM, LENGTH 400 MM X-WIRE WITHOUT OLIVE
O 5200-0437	2 MM, LENGTH 450 MM
O 5200-0438	ALUMINUM BOX

## O5200-0500 ILIZAROV CIRCULAR EXTERNAL FIXATOR INSTRUMENT SET

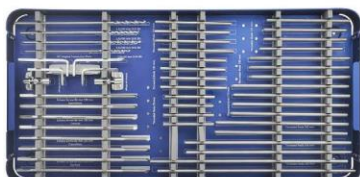

O5200-0501	WRENCH WITH OPEN-CIRCULAR ENDS
O5200-0502	HEXAGONAL WRENCH 6 MM
O5200-0503	PROTECTION SLEEVE GUIDE
O5200-0504	TROCAR
O5200-0506	T-HANDLE WITH JACOB'S CHUCK SMALL
O5200-0508	DOUBLE ENDED OFFSET SOCKET WRENCH
O5200-0509	WIRE TENSIONER 0014
O5200-0511	HEXAGONAL WRENCH 4 MM
O5200-0513	Ø4,5 MM DRILL SLEEVE
O5200-0514	Ø3,5 MM DRILL SLEEVE
O5200-0515	Ø5 MM SCHANZ SLEEVE
O5200-0516	Ø6 MM SCHANZ SLEEVE
O5200-0518	HEXAGONAL WRENCH 3 MM
O5200-0517	ALUMINUM BOX

## O5200-0600 PEDIATRIC ILIZAROV CIRCULAR EXTERNAL FIXATOR INSTRUMENT SET



O5200-0506	DOUBLE ENDED OFFSET SOCKET WRENCH 8/8 (DOUBLE ENDED OFFSET SOCKET WRENCH)
O5200-0605	WRENCH 9/8 MM (WRENCH WITH TWO OPEN ENDS)
O5200-0611	PROTECTION SLEEVE GUIDE
O5200-0612	WIRE TENSIONER
O5200-0618	HEXAGONAL WRENCH 2,5 MM
O5200-0619	HEXAGONAL WRENCH 3 MM
O5200-0620	HEXAGONAL WRENCH 4 MM
O5200-0621	HEXAGONAL WRENCH 5 MM
O5200-0622	TROCHAR
O5200-0623	SLEEVE FOR 2,2 DRILL
O5200-0624	SLEEVE FOR 2,7 DRILL
O5200-0625	SLEEVE FOR 3,2 DRILL
O5200-0626	SLEEVE FOR 3,0 SCHANZ SCREW
O5200-0627	SLEEVE FOR 3,5 SCHANZ SCREW
O5200-0628	SLEEVE FOR 4,0 SCHANZ SCREW
O5200-0617	ALUMINUM BOX

## O6200-0100 PIN-WIRE INSTRUMENT SET

O6200-0101	WISE GRIP
O6200-0102	T-HANDLE WITH JACOB'S CHUCK SMALL
O6200-0103	WIRE BENDING
O6200-0104	WIRE CUTTER -1
O6200-0105	WIRE CUTTER -2
O6200-0106	WIRE PASSER

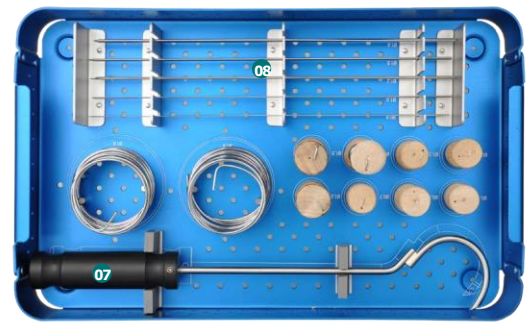

## O5201-0100 FLEXIBLE REAMER SURGERY INSTRUMENT SET

O 5201-0101	FLEXIBLE REAMER Ø7,5 MM
O 5201-0102	FLEXIBLE REAMER Ø8,0 MM
O 5201-0103	FLEXIBLE REAMER BIT Ø7,5 MM
O 5201-0104	FLEXIBLE REAMER BIT Ø8,0 MM
O 5201-0105	FLEXIBLE REAMER BIT Ø8,5 MM
O 5201-0106	FLEXIBLE REAMER BIT Ø9,0 MM
O 5201-0107	FLEXIBLE REAMER BIT Ø9,5 MM
O 5201-0108	FLEXIBLE REAMER BIT Ø 10 MM
O 5201-0109	FLEXIBLE REAMER BIT Ø 10,5 MM
O 5201-0110	FLEXIBLE REAMER BIT Ø 11 MM
O 5201-0111	FLEXIBLE REAMER BIT Ø 11,5 MM
O 5201-0112	FLEXIBLE REAMER BIT Ø 12 MM
O 5201-0113	FLEXIBLE REAMER BIT Ø 12,5 MM
O 5201-0114	FLEXIBLE REAMER BIT Ø 13 MM
O 5201-0115	T-HANDLE WITH QUICK COUPLING
O 5201-0116	ALUMINIUM BOX

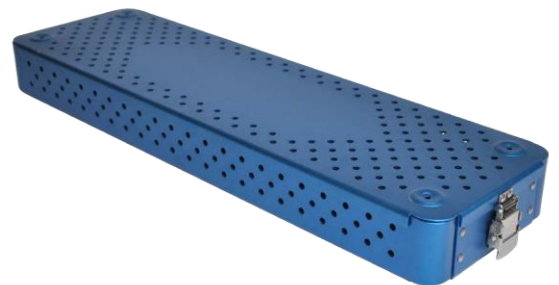
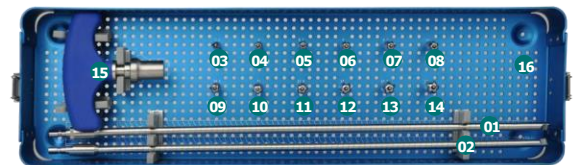

## O4200-1700 CABLE INSTRUMENT SET

O4200-1701	STERILIZATION CASE
O4200-1702	ATTACHMENT BITS
O4200-1703	CABLE TENSIONER
O4200-1704	MEDIUM CABLE PASSER-CURVED
O4200-1705	LARGE CABLE PASSER-CURVED
O4200-1706	LARGE CABLE PASSER
O4200-1707	LARGE CABLE PASSER -45°
O4200-1708	MEDIUM CABLE PASSER
O4200-1709	FORCEPS
O4200-1710	PROVISIONAL TENSIONING DEVICES
O4200-1711	CABLE CRIMPER
O4200-1712	CABLE CUTTER-LARGE
O4200-1713	CABLE CUTTER-STANDARD

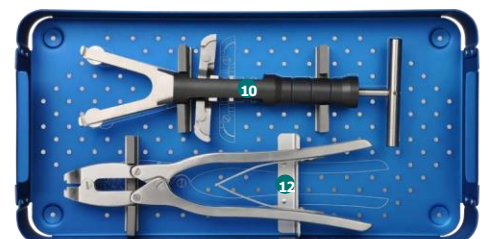
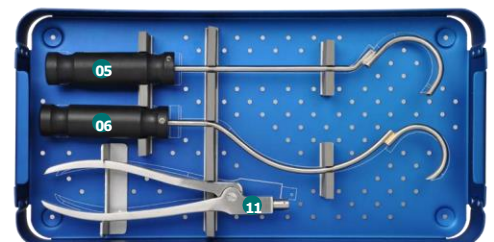

# *Samis Instruments*

[www.samisinstruments.com](http://www.samisinstruments.com)

## **Factory Address:**

- Samis Instruments,
- Block C Commercial Area,
- Citi Housing Society,
- Sialkot, Punjab 51410, Pakistan
- **Office Address:** Samis Instruments,
- Brooklyn, New York, NY 11201, USA

“  
**Quality  
in  
Health**”

