

# SAMIS INSTRUMENTS

## GENERAN INSTRUMENTS

Artery Forceps	10
Clamps	13
Spring Forceps	14
Tissue Forceps	16
Sponge Holding and Sterilising Forceps	18
Other Forceps	19
Scissors	20
Needle Holders	25
Combined Scissor and Needle Holders	29
Bag and Towel Clips	30
Retractors	31
Dissectors and Probes	39
Miscellaneous	40
Hollow Ware	41
Silicone Matting	42
Wire Sterilising Baskets	42
Optical Fibre Cables	44

# SAMIS INSTRUMENTS

## Adson Artery Forceps

Box joint, 180mm long

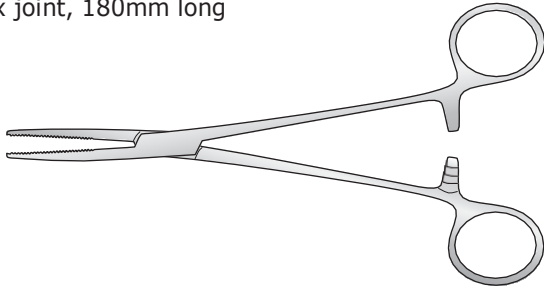

### Serrated jaws

Code	Description
SC-GI/034	Straight
SC-GI/034a	Curved

### 1-2 teeth

Code	Description
SC-GI/034b	Straight
SC-GI/034c	Curved

## Cushing Artery Forceps

Box joint, fine, half serrated jaws, 140mm long

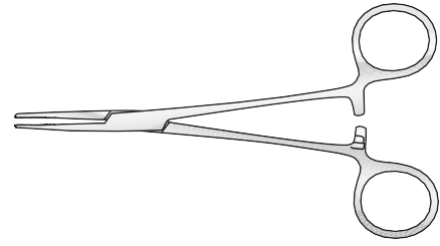

Code	Description
SC-GI/001	Straight
SC-GI/002	Curved

## Cairns Artery Forceps

Box joint, half serrated jaws  
145mm long

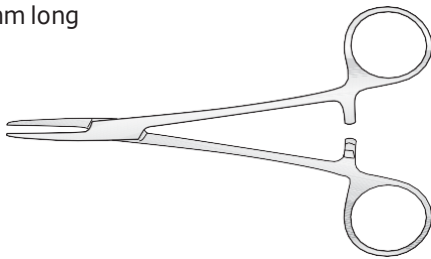

### Serrated jaws

Code	Description
SC-GI/415	Straight

### 1-2 teeth

Code	Description
SC-GI/020	Curved
SC-GI/021	Curved to side

## Dunhill Artery Forceps

Box joint, fine serrations

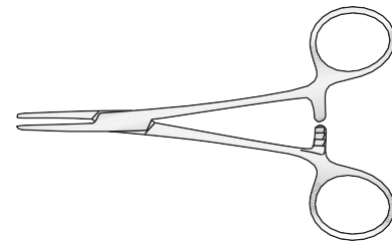

### Straight

Code	Description
SC-GI/065	135mm long
SC-GI/065a	190mm long

### Curved

Code	Description
SC-GI/043	135mm long
SC-GI/468	180mm long

## Crile Artery Forceps

Box joint, serrated jaws

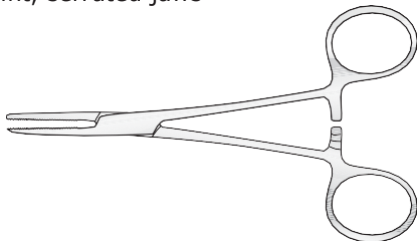

### Straight

Code	Description
SC-GI/014	140mm long
SC-GI/014a	160mm long

### Curved

Code	Description
SC-GI/015	140mm long
SC-GI/015a	160mm long

## Lawson Tait Artery Forcep

Box joint, straight jaw

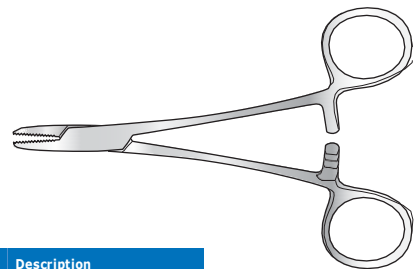

Code	Description
SC-GI/SH5924	140mm long

## Halstead Mosquito Forceps

Standard pattern, haemostatic, box joint

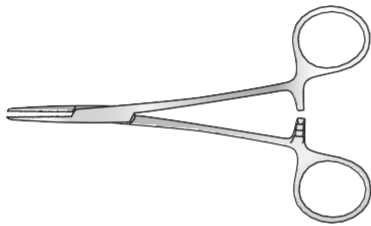

### Serrated jaw

Code	Description
SC-GI/007	Straight 125mm long
SC-GI/008	Curved 125mm long
SC-GI/009	Fully curved 125mm long

### 1-2 teeth

Code	Description
SC-GI/010	Straight 125mm long
SC-GI/012	Straight 190mm long
SC-GI/011	Curved 125mm long
SC-GI/013	Curved 190mm long



### Micro, 100mm long

Code	Description
SC-GI/003	Straight, serrated
SC-GI/004	Curved, serrated
SC-GI/005	Straight, 1-2teeth
SC-GI/006	Curved, 1-2teeth

## Heiss Artery Forceps

Box joint, 205mm long

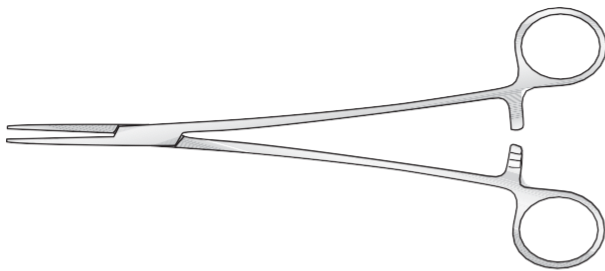

### Serrated jaws

Code	Description
SC-GI/016	Straight
SC-GI/017	Curved



### 1-2 teeth

Code	Description
SC-GI/016a	Straight
SC-GI/017b	Curved

## Kelly Artery Forceps

Box joint, half serrated jaws



### Straight

Code	Description
SC-GI/022	140mm long
SC-GI/023	160mm long



### Curved

Code	Description
SC-GI/024	140mm long
SC-GI/025	160mm long

## Fraser Kelly Artery Forceps Curved

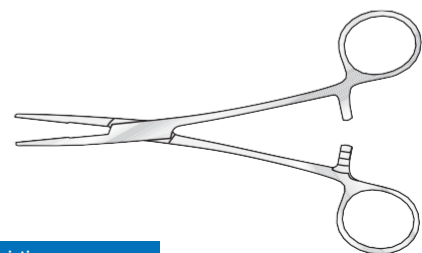

### Straight

Code	Description
SC-GI/468a	180mm

## Kocher Artery Forceps

Box joint, 1-2 teeth

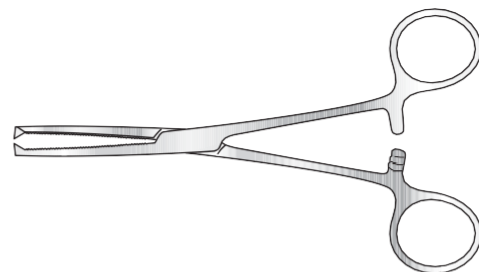

### Straight

SC-GI/052	130mm long
SC-GI/053	150mm long
SC-GI/054	180mm long
SC-GI/055	200mm long
SC-GI/056	230mm long



### Curved

SC-GI/057	150mm long
SC-GI/058	180mm long
SC-GI/059	200mm long
SC-GI/060	230mm long

# SAMIS INSTRUMENTS

## Moynihan Artery Forceps

Box joint, half-serrated jaws

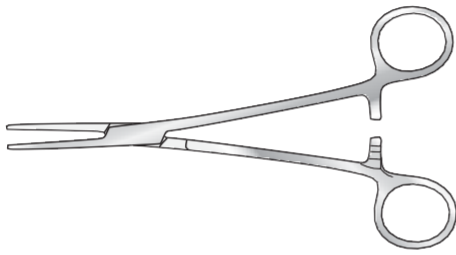

### Straight

Code	Description
SC-GI/018	145mm long
SC-GI/068	180mm long

### Curved

Code	Description
SC-GI/019	145mm long
SC-GI/069	180mm long

## Rochester-Pean Artery Forceps

Box joint

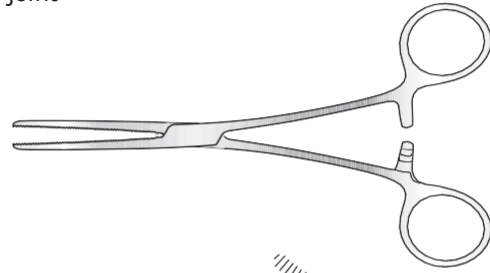

### Straight

Code	Description
SC-GI/044	165mm long
SC-GI/045	190mm long
SC-GI/046	205mm long
SC-GI/047	240mm long

### Curved

Code	Description
SC-GI/048	165mm long
SC-GI/049	180mm long
SC-GI/050	205mm long
SC-GI/051	240mm long

## Roberts Artery Forceps

Screw joint, curved on flat, serrated

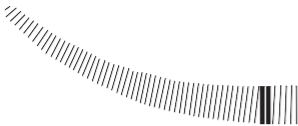
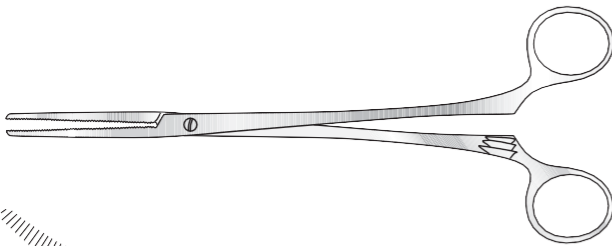

Code	Description
SC-GI/070	230mm long

## Spencer Wells Artery Forceps

Box joint, serrated jaws

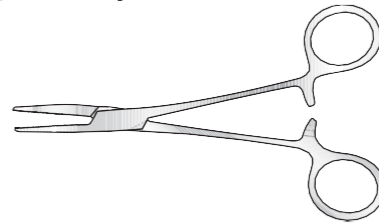

### Straight

Code	Description
SC-GI/035	127mm long
SC-GI/036	152mm long
SC-GI/037	177mm long
SC-GI/038	203mm long

### Curved

Code	Description
SC-GI/039	127mm long
SC-GI/040	152mm long
SC-GI/041	177mm long
SC-GI/042	203mm long

OTHER SIZES AVAILABLE

## Dandy Artery Forceps

Box joint, curved in plane

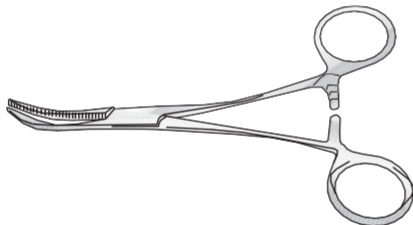

Code	Description
SC-GI/076	140mm long



## Carmalt Angiotribe Forceps

Box joint, atraumatic, light pattern

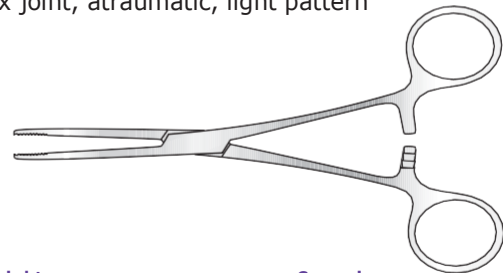

### Straight

Code	Description
SC-GI/062	165mm long
SC-GI/063	200mm long
SC-GI/064	230mm long

### Curved

Code	Description
SC-GI/061	165mm long

## Die"enbach Bulldog Clamp

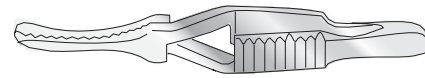
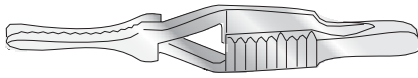

### Straight, serrated

Code	Description
SC-GI/112	1.2mm fine jaw, 40mm long
SC-GI/113	1.2mm fine jaw, 45mm long
SC-GI/108	1.8mm jaw, 30mm long
SC-GI/109	1.8mm jaw, 35mm long
SC-GI/110	2.5mm jaw, 40mm long
SC-GI/111	2.5mm jaw, 45mm long
SC-GI/107	6mm heavy jaw, 60mm long
SC-GI/455	20mm jaw, 75mm long
SC-GI/455a	30mm jaw, 85mm long
SC-GI/455b	45mm jaw, 105mm long
SC-GI/455c	65mm jaw, 120mm long

### Straight, plain

Code	Description
SC-GI/129	1.2mm fine jaw, 40mm long
SC-GI/131	1.2mm fine jaw, 45mm long
SC-GI/121	1.8mm jaw, 30mm long
SC-GI/123	1.8mm jaw, 35mm long
SC-GI/125	2.5mm jaw, 40mm long
SC-GI/127	2.5mm jaw, 45mm long

### Curved, serrated

Code	Description
SC-GI/119	1.2mm fine jaw, 40mm long
SC-GI/120	1.2mm fine jaw, 45mm long
SC-GI/115	1.8mm jaw, 30mm long
SC-GI/116	1.8mm jaw, 35mm long
SC-GI/117	2.5mm jaw, 40mm long
SC-GI/118	2.5mm jaw, 45mm long
SC-GI/114	6mm heavy jaw, 60mm long
SC-GI/456	20mm jaw, 75mm long
SC-GI/456a	30mm jaw, 85mm long
SC-GI/456b	45mm jaw, 105mm long
SC-GI/456c	65mm jaw, 120mm long

### Curved, plain

Code	Description
SC-GI/130	1.2mm fine jaw, 40mm long
SC-GI/132	1.2mm fine jaw, 45mm long
SC-GI/122	1.8mm jaw, 30mm long
SC-GI/124	1.8mm jaw, 35mm long
SC-GI/126	2.5mm jaw, 40mm long
SC-GI/128	2.5mm jaw, 45mm long

## Blalock Bulldog Clamp



### Serrated, with hole in handle

#### Straight

Code	Description
SC-GI/480	11mm jaw, 38mm long
SC-GI/482	14mm jaw, 48mm long
SC-GI/493	17mm jaw, 60mm long
SC-GI/481	27mm jaw, 70mm long

#### Curved

Code	Description
SC-GI/478	11mm jaw, 38mm long
SC-GI/479	14mm jaw, 48mm long
SC-GI/491	17mm jaw, 60mm long
SC-GI/492	27mm jaw, 70mm long

### Plain, with hole in handle

#### Straight

Code	Description
SC-GI/486	11mm jaw, 38mm long
SC-GI/487	14mm jaw, 48mm long
SC-GI/488	17mm jaw, 60mm long
SC-GI/489	27mm jaw, 70mm long

#### Curved

Code	Description
SC-GI/483	11mm jaw, 38mm long
SC-GI/484	14mm jaw, 48mm long
SC-GI/485	17mm jaw, 60mm long
SC-GI/490	27mm jaw, 70mm long

## An Overview On

# Forcep Jaw Types

You will see that forceps in our catalogue will have either a traditional serrated jaw or a different design which is known as atraumatic (or non-traumatic).

### Traditional Serrated Jaw



The traditional serrated jaw is generally more robust and used on forceps where the areas are not as delicate.

### Atraumatic Jaw



Atraumatic jaws will be mainly found in delicate surgery areas such as vascular and cardiothoracic. The design is such, that the surface area gripped is reduced, ensuring less trauma without the loss of grip.

# SAMIS INSTRUMENTS

## Adsons Dissecting Forceps

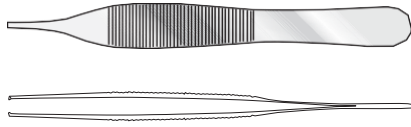

127mm long

Code	Description
SC-GI/257	1-2 teeth
SC-GI/258	Lightweight, micro
SC-GI/259	Serrated
SC-GI/260	Serrated, lightweight, micro

## DeBakey Atraumatic Dissecting Forceps

Straight, atraumatic jaws

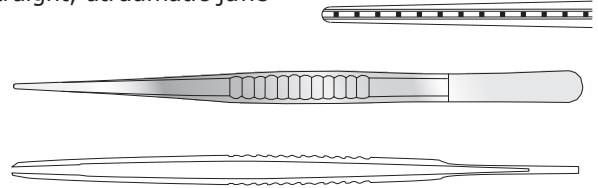

1.5mm

Code	Description
SC-GI/238a	150mm long
SC-GI/240a	240mm long

2.5mm

Code	Description
SC-GI/238b	150mm long
SC-GI/240b	240mm long

## Block End Dissecting Forceps

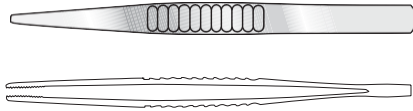

Serrated

Code	Description
SC-GI/255	127mm long
SC-GI/256	152mm long
SC-GI/256a	203mm long

2mm

Code	Description
SC-GI/238	150mm long
SC-GI/241	180mm long

2.8mm

Code	Description
SC-GI/238c	150mm long
SC-GI/240c	240mm long
SC-GI/241c	180mm long

## Bonney Dissecting Forceps

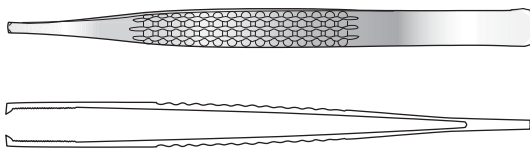

178mm long

Code	Description
SC-GI/267	Serrated, 1-2 teeth
SC-GI/268	1-2 teeth

## Dissecting Forceps

Turnover end, serrated jaws

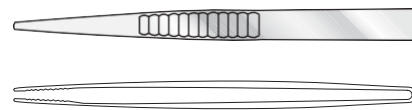

Code	Description
SC-GI/242	127mm long
SC-GI/243	152mm long

Code	Description
SC-GI/244	178mm long
SC-GI/245	203mm long

## Charnley-McIndoe Dissecting Forceps

150mm long

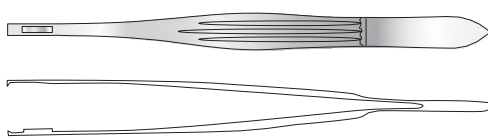

Code	Description
SC-OR/N045a	2-3 teeth

## Dunhill Dissecting Forceps

Light, fine serrated jaws



Code	Description
SC-GI/457	145mm long

## Fredrick Coole Dissecting Forceps

Extra fine serrated jaws

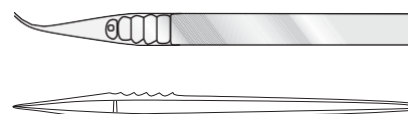

125mm long

Code	Description
SC-GI/066	Straight
SC-GI/067	Curved

## Gillies Dissecting Forceps

1-2 teeth

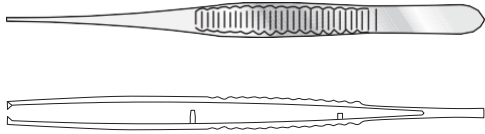

Code	Description
SC-PL/052	152mm long

## McIndoe Dissecting Forceps

152mm long

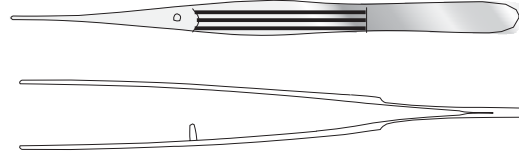

Code	Description
SC-GI/476	Serrated
SC-GI/477	1-2 teeth

## Jackson Burrows Dissecting Forceps

140mm long

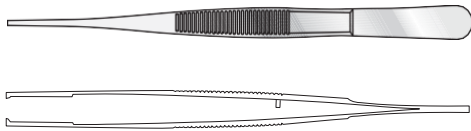

Code	Description
SC-OR/N037	Tongue and groove, 1-2teeth
SC-OR/N037a	Tongue and groove only

## McIndoe Modified Dissecting Forceps

152mm long, 1mm tip, modified for fine powerful dissection with strong action tip



Code	Description
SH/5961	Serrated

## Jean Dissecting Forceps

Serrated jaws, 140mm long

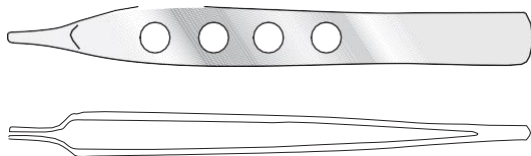

Code	Description
SC-GI/269	Fine
SC-GI/270	1-2 teeth
SC-GI/271	2-3 teeth, 178mm long

## Treves Dissecting Forceps

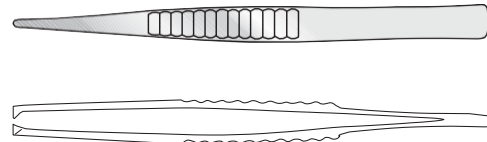

1-2 teeth

Code	Description
SC-GI/251	127mm long
SC-GI/252	152mm long

2-3 teeth

Code	Description
SC-GI/253	127mm long
SC-GI/254	152mm long

## Lanes Dissecting Forceps

1-2 teeth on serrated jaws, 140mm long

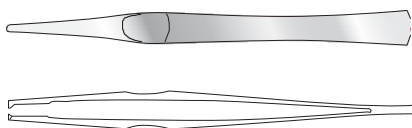

Code	Description
SC-GI/246	127mm long
SC-GI/247	152mm long
SC-GI/248	178mm long

Code	Description
SC-GI/249	2-3 teeth, 178mm long
SC-GI/250	2-3 teeth 203mm long

## Waugh Dissecting Forceps



Fine, serrated

Code	Description
SC-GI/261	152mm long
SC-GI/262	178mm long
SC-GI/263	203mm long

Fine, 1-2 teeth

Code	Description
SC-GI/264	152mm long
SC-GI/265	178mm long
SC-GI/266	203mm long

# SAMIS INSTRUMENTS

## Allis Tissue Forceps

Box joint

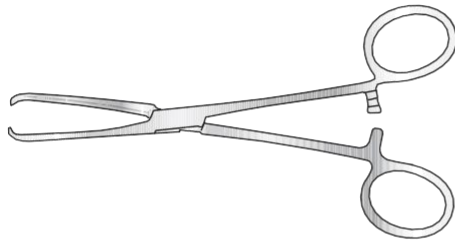

150mm long

Code	Description
SC-GI/272	3-4 teeth
SC-GI/273	4-5 teeth

190mm long

Code	Description
SC-GI/414	5-6 teeth

## Duval Tissue Forceps

Box joint

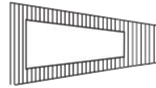
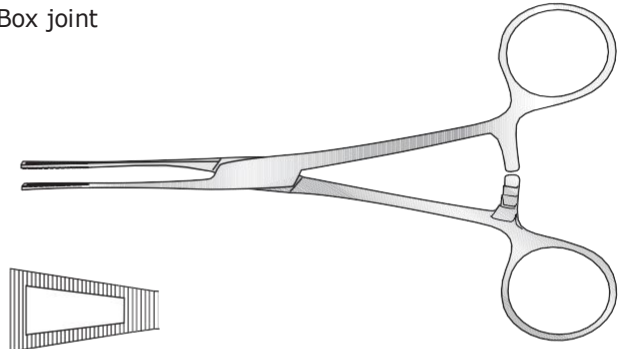

Code	Description
SC-GI/279	13mm wide, 203mm long

## Littlewood Tissue Forceps

Box joint, 2-3 teeth

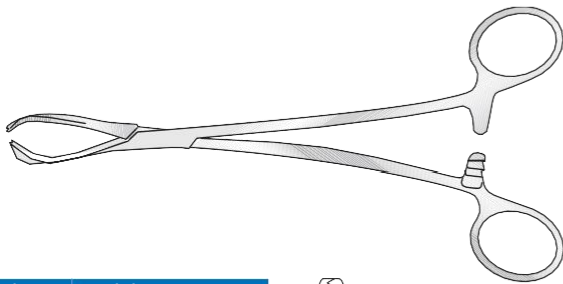

Code	Description
SC-GI/275	190mm long

## Lane Tissue Forceps

Box joint, 1-2 teeth, fenestrated

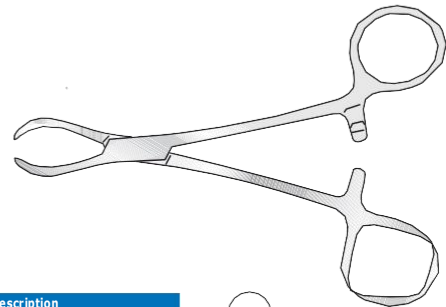

Code	Description
SC-GI/280	127mm long
SC-GI/281	152mm long
SC-GI/282	197mm long

## Babcock Tissue Forceps

Box joint, serrated jaws

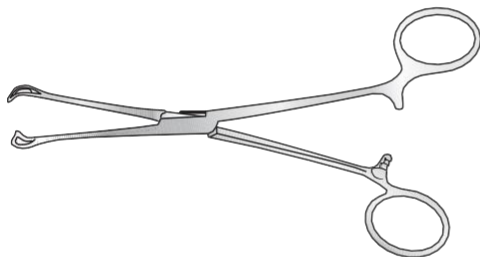

Code	Description
SC-GI/276	160mm long
SC-GI/277	200mm long
SC-GI/278	230mm long

## Rutherford Morrison Tissue Forceps

Box joint

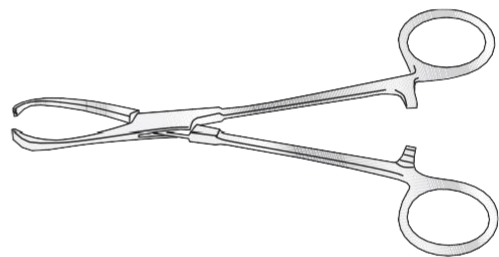

Code	Description
SC-GI/283	4-5 teeth, 152mm long

## Shaw Tissue Forceps

Box joint

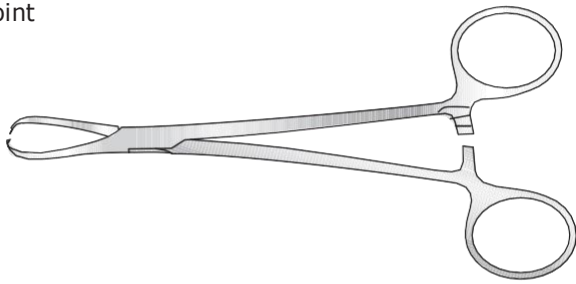

Code	Description
SC-GI/458	1-2 teeth, 178mm long

## Guys Gallabin Suture-Holding Forceps

Screw joint, angled flat blades

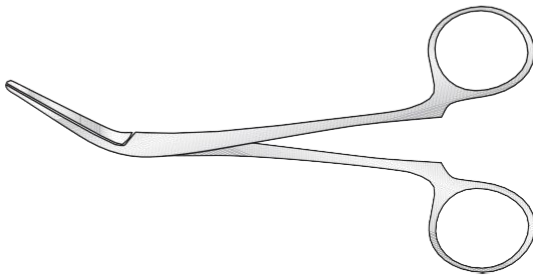

Code	Description
SC-GI/450	125mm long
SC-GI/4402	150mm long

## Russian Dissecting Forceps

With fenestrated end



Code	Description
SC-GI/SH-5503b	150mm long
SC-GI/SH-5503	200mm long
SC-GI/403	230mm long
SC-GI/SH-5503a	250mm long

## Special Offer

on SSD Essentials Pack

Top up your trays with these essentials...

CONTACT US FOR OUR OFFER PRICE

### Halstead Mosquito Forceps

Straight/Curved  
125mm (5")

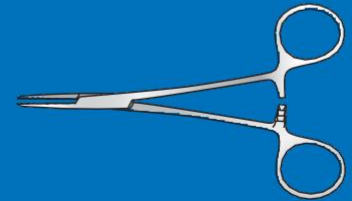

### Ramsey Sponge Holding Forceps

Straight, Serrated  
Jaws 241mm  
(9 1/2")

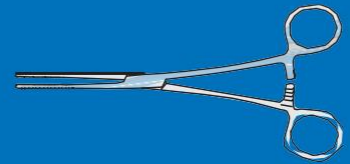

### Scalpel Blade Handle

No. 3



### Spring Clip

Serrated Pattern,  
Stainless Steel for  
Fixing Slings to Leg  
Splints, also for  
Towel Clipping  
6.3cm (2 1/2") Wide

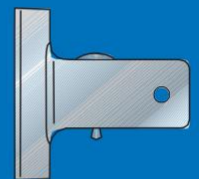

### Spencer Wells Artery Forceps

Straight, Serrated  
Jaws

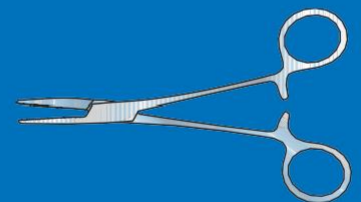

Email us to place your order

EMAIL  
SAMISINSTRUMENTS.COM

# SAMIS INSTRUMENTS

## Rampley Sponge Holding Forceps

Box joint, straight, serrated jaws

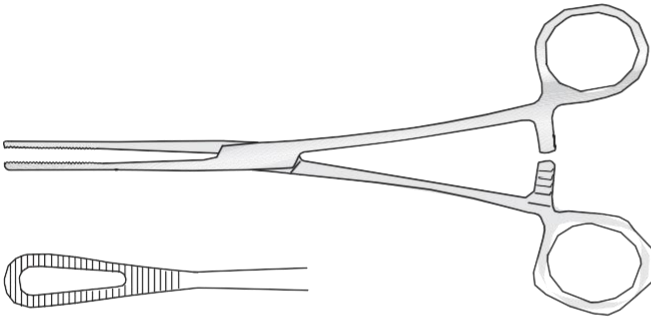

Code	Description
SC-GI/353	178mm long
SC-GI/354	241mm long

## Lister Sinus Forceps

Box joint, serrated tip

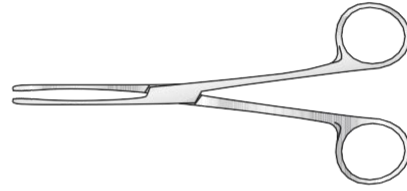

Code	Description
SC-GI/367	127mm long
SC-GI/368	152mm long
SC-GI/369	178mm long

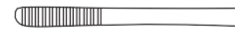

## Foerster Sponge Holding Forceps

Box joint, straight, serrated jaws

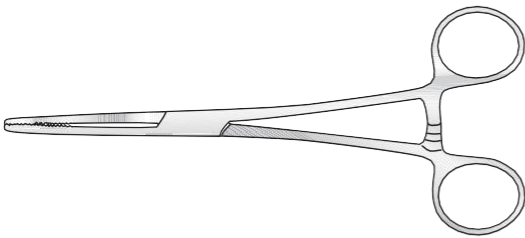

Code	Description
SC-GI/354a	178mm long

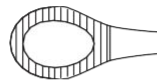

## Cheatele Sterilizer Forceps

Screw joint

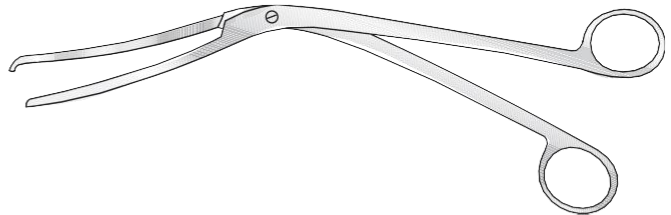

Code	Description
SC-GI/364	267mm long

## Harrison Bowl Steriliser Forceps

Screw joint, angled, double jaw

Code	Description
SC-GI/365	356mm long
SC-GI/366	457mm long

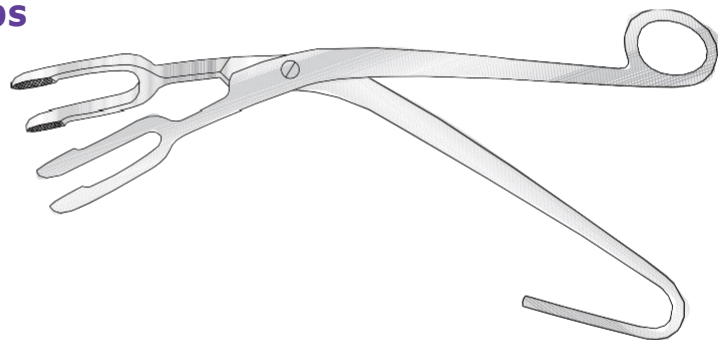

## Hunter Splinter Forceps

Serrated grooved pointed jaws

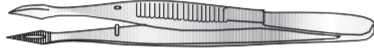

Code	Description
SC-GI/360	115mm long

## Michel Forceps

Box joint, double-ended, for inserting and removing clips stainless steel

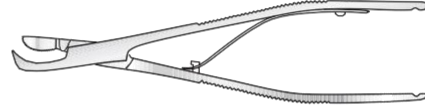

Code	Description
SC-GI/357	130mm long

## Michel Skin Holding Forceps

With magazine for Michel clips

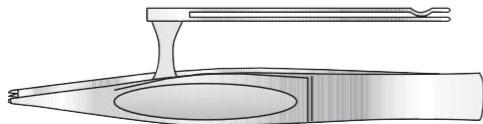

Code	Description
SC-GI/358	1-2 teeth, 127mm long

## Michel Clip Extracting Forceps

Box joint

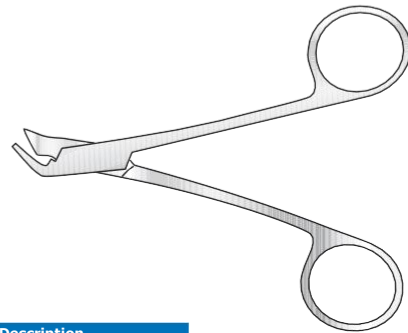

Code	Description
SC-GI/359	125mm long

## Childe Approximating Forceps

With magazine for Michel clips

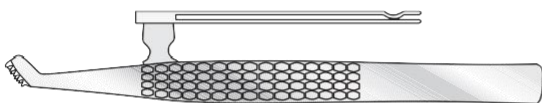

Code	Description
SC-GI/469	180mm long

## Robins Anchoring Forceps

140mm long

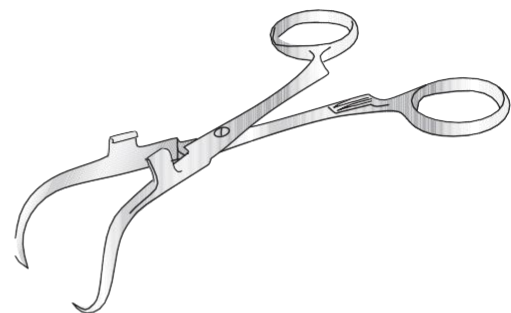

Code	Description
SC-GI/453	5mm with holder for diathermy leads
SC-GI/453a	13mm with holder for suction tubing

# SAMIS INSTRUMENTS

## Dressing Scissors

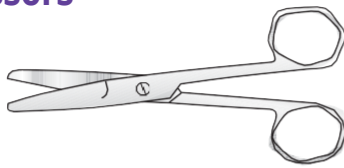

### Blunt/Blunt Straight

Code	Description
SC-GI/133	130mm long
SC-GI/136	146mm long
SC-GI/139	165mm long

### Curved

Code	Description
SC-GI/142	130mm long
SC-GI/143	146mm long
SC-GI/144	165mm long
SC-GI/145	185mm long
SC-GI/404	147mm long

With one serrated blade

### Blunt/Sharp Straight

Code	Description
SC-GI/134	130mm long
SC-GI/137	146mm long
SC-GI/140	165mm long

### Sharp/Sharp Straight

Code	Description
SC-GI/135	130mm long
SC-GI/138	146mm long
SC-GI/141	165mm long

### Curved

Code	Description
SC-GI/146	130mm long

## Dressing Scissors, Left-Handed

With one black bow, 145mm long

### Blunt/Blunt

Code	Description
SC-GI/192	Straight
SC-GI/193	Curved

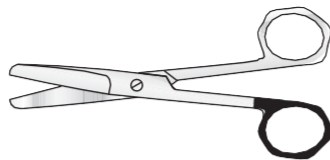

### Blunt/Sharp

Code	Description
SC-GI/194	Straight
SC-GI/195	Curved

### Sharp/Sharp

Code	Description
SC-GI/196	Straight
SC-GI/197	Curved

## Little Dissecting Scissors

Fine pattern, with eye for suture

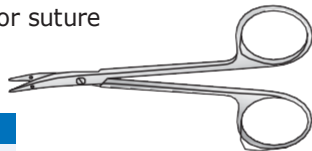

Code	Description
SC-PL/001f	115mm long

## Kilner Dissecting Scissors

Fine pattern



Code	Description
SC-PL/001a	115mm long

## Metzenbaum Scissors

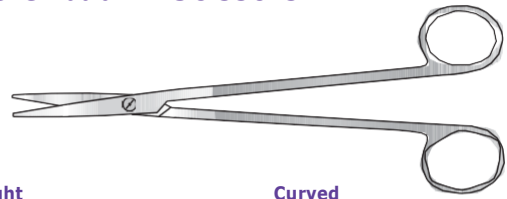

### Straight

Code	Description
SC-GI/405	180mm long
SC-GI/406	147mm long
SC-GI/406a	200mm long
SC-GI/406b	230mm long
SC-GI/406c	250mm long
SC-GI/406d	280mm long

### Curved

Code	Description
SC-GI/407	185mm long
SC-GI/408	147mm long
SC-GI/408a	200mm long
SC-GI/408b	230mm long
SC-GI/408c	250mm long
SC-GI/408d	280mm long

## Mayo Scissors



### Straight

Code	Description
SC-GI/409	140mm long
SC-GI/409a	160mm long
SC-GI/411	190mm long
SC-GI/411a	230mm long

### Curved

Code	Description
SC-GI/410	140mm long
SC-GI/410a	160mm long
SC-GI/412	190mm long
SC-GI/412a	230mm long

## Fergusson Scissors

Angled on flat

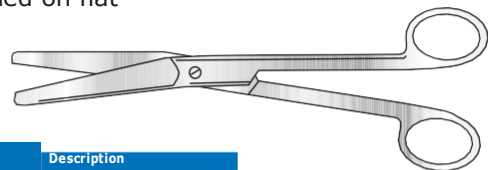

Code	Description
SC-GI/148	180mm long

## Paynes Suture Scissors

Code	Description
SC-GI/152	100mm long



## Ligature Stitch Scissors

Fine pattern

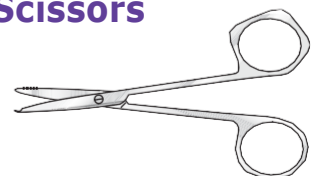

Code	Description
SC-GI/153	115mm long



## Lister Bandage Scissors

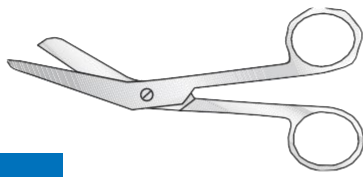

Code	Description
SC-GI/154	147mm long
SC-GI/155	178mm long

## Lister Bandage Scissors

Angled, with probe end

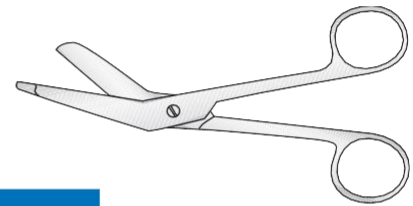

SC-GI/361	147mm long
SC-GI/362	178mm long

## McIndoe Scissors

178mm long

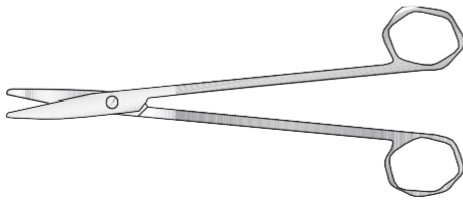

Code	Description
SC-GI/149	Straight
SC-GI/150	Curved on flat
SC-GI/150sc	Supercut, curved



## Thomas Strabismus Scissors

114mm long

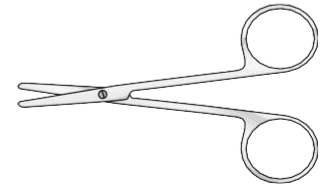

Code	Description
SC-OP/030	Straight
SC-OP/029	Curved

## Heath Stitch Scissors

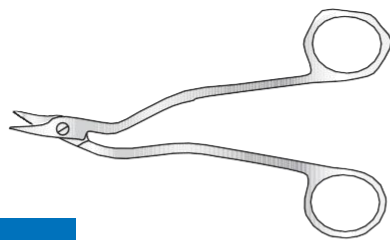

Code	Description
SC-GI/151	152mm long

## "Careless" Scissors

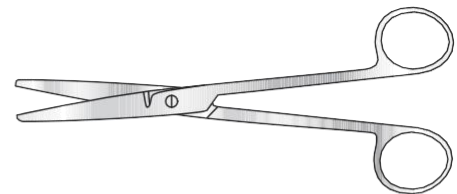

Code	Description
SC-GI/474	165mm long

## Tubing Scissors

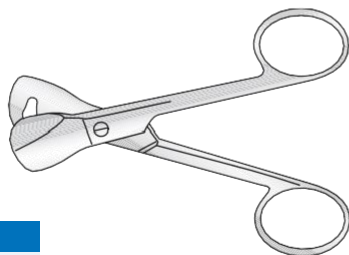

Code	Description
SC-GI/147	130mm long

## Utility Scissors



SC-GI/466	190mm long
-----------	------------

# SAMIS INSTRUMENTS

## Dressing Scissors

Tungsten carbide hard insert, blunt/blunt

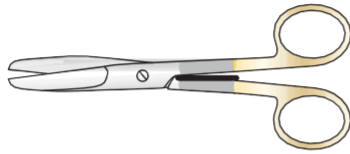

**Straight**

Code	Description
SC-GI/430	130mm long
SC-GI/432	145mm long
SC-GI/434	165mm long
SC-GI/436	185mm long

**Curved**

Code	Description
SC-GI/431	130mm long
SC-GI/433	145mm long
SC-GI/435	165mm long

## Mayo Dressing Scissors

Tungsten carbide hard insert

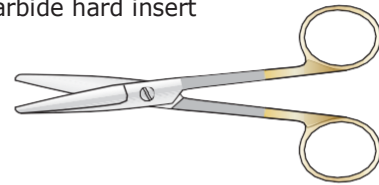

**Straight**

Code	Description
SC-GI/419	140mm long
SC-GI/419a	160mm long
SC-GI/421	190mm long
SC-GI/421a	230mm long

**Curved**

Code	Description
SC-GI/420	140mm long
SC-GI/420a	160mm long
SC-GI/422	190mm long
SC-GI/422a	230mm long

## Dressing Scissors

Tungsten carbide hard insert, blunt/sharp

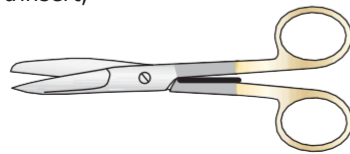

**Straight**

Code	Description
SC-GI/423	130mm long
SC-GI/425	145mm long
SC-GI/427	165mm long
SC-GI/429	185mm long

**Curved**

Code	Description
SC-GI/424	130mm long
SC-GI/426	145mm long
SC-GI/428	165mm long

## Mayo-Harrington Dressing Scissors

Tungsten carbide hard insert

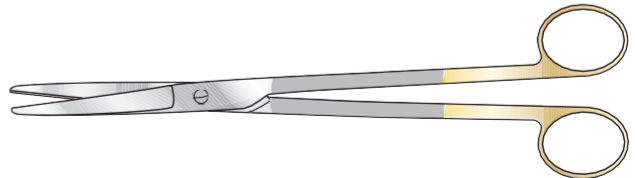

**230mm long**

Code	Description
SC-GI/417	Straight
SC-GI/418	Curved

**200mm long**

Code	Description
SC-GI/162a	Straight
SC-GI/413b	Curved

## Dressing Scissors

Tungsten carbide hard insert sharp/sharp

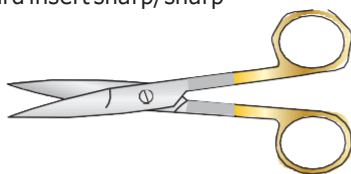

**Straight**

Code	Description
SC-GI/437	130mm long
SC-GI/439	145mm long
SC-GI/441	165mm long
SC-GI/443	185mm long

**Curved**

Code	Description
SC-GI/438	130mm long
SC-GI/440	145mm long
SC-GI/442	165mm long

## Metzenbaum Scissors

Tungsten carbide hard insert

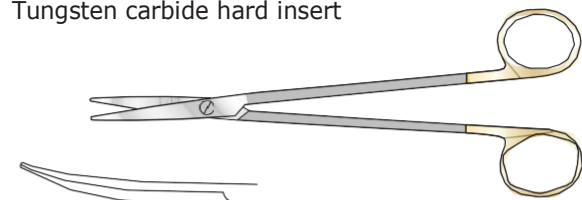

**230mm long**

Code	Description
SC-GI/445	145mm long
SC-GI/448	185mm long
SC-GI/471a	230mm long
SC-GI/471b	250mm long
SC-GI/471c	280mm long

**200mm long**

Code	Description
SC-GI/446	145mm long
SC-GI/449	185mm long
SC-GI/449a	200mm long
SC-GI/449b	230mm long
SC-GI/449c	250mm long
SC-GI/449d	280mm long

## Baby Metzenbaum Scissors

Tungsten carbide, hard insert, 145mm long

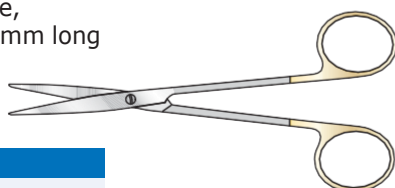

Code	Description
SC-GI/445a	Straight
SC-GI/446a	Curved

## Ligature Scissors

Tungsten carbide hard insert, curved

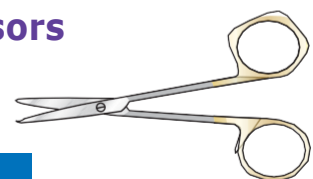

Code	Description
SC-GI/444	145mm long
SC-GI/447	185mm long

## Mayo Harrington Scissors

Supercut, tungsten carbide

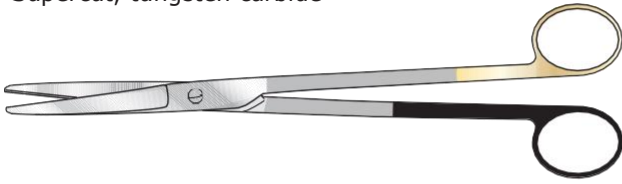

### 230mm long

Code	Description
SC-GI/162	Straight
SC-GI/413	Curved

### 200mm long

Code	Description
SC-GI/162b	Straight
SC-GI/413b	Curved

## Mayo Scissors

Supercut, tungsten carbide

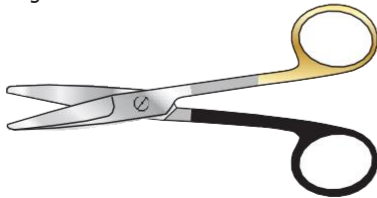

### Straight

Code	Description
SC-GI/163	140mm long
SC-GI/163a	160mm long
SC-GI/165	190mm long
SC-GI/165a	230mm long

### Curved

Code	Description
SC-GI/164	140mm long
SC-GI/164a	160mm long
SC-GI/166	190mm long
SC-GI/166a	230mm long

## Metzenbaum Dissecting Scissors

Supercut, tungsten carbide



### Straight

Code	Description
SC-GI/188tc	185mm long
SC-GI/188tca	200mm long
SC-GI/188tcb	230mm long
SC-GI/188tcc	250mm long
SC-GI/188tcd	280mm long

### Curved

Code	Description
SC-GI/191tc	147mm
SC-GI/189tc	185mm
SC-GI/186tca	200mm
SC-GI/188tcb	230mm
SC-GI/188tcc	250mm
SC-GI/188tcd	280mm

## Dressing Scissors

Supercut, tungsten carbide

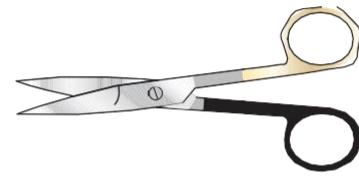

### Blunt/Blunt

#### Straight

Code	Description
SC-GI/174	130mm long
SC-GI/176	145mm long
SC-GI/178	165mm long
SC-GI/180	185mm long

#### Curved

Code	Description
SC-GI/175	130mm long
SC-GI/177	145mm long
SC-GI/179	165mm long
SC-GI/180a	185mm long

### Blunt/Sharp

#### Straight

Code	Description
SC-GI/167	130mm long
SC-GI/169	145mm long
SC-GI/171	165mm long
SC-GI/173	185mm long

#### Curved

Code	Description
SC-GI/168	130mm long
SC-GI/170	145mm long
SC-GI/172	165mm long
SC-GI/173a	185mm long

### Sharp/Sharp

#### Straight

Code	Description
SC-GI/181	130mm long
SC-GI/183	145mm long
SC-GI/185	165mm long
SC-GI/187	185mm long

#### Curved

Code	Description
SC-GI/182	130mm long
SC-GI/184	145mm long
SC-GI/186	165mm long
SC-GI/187a	185mm long

## Guide for Gold and Black Bows

It's important to know the difference for the intended use of each scissor:



**2 Gold Bows**  
Tungsten carbide insert or padding for a scissor



**2 Black Bows**  
Supercut edge



**1 Black and 1 Gold Bow**  
Supercut tungsten carbide



**1 Black Bow (left ring)**  
Left-handed instrument

## Dressing Scissors

Supercut, blunt/blunt



145mm long

Code	Description
SC-GI/160	Straight
SC-GI/161	Curved

## Dressing Scissors

Supercut, blunt/sharp



145mm long

Code	Description
SC-GI/156	Straight
SC-GI/157	Curved

## Dressing Scissors

Supercut, sharp/sharp



145mm long

Code	Description
SC-GI/158	Straight
SC-GI/159	Curved

## Mayo Scissors

Supercut



Straight

Code	Description
SC-GI/166a	140mm long
SC-GI/166e	160mm long
SC-GI/166b	170mm long

Curved

Code	Description
SC-GI/166c	140mm long
SC-GI/166f	160mm long
SC-GI/166d	170mm long

## Boyd Scissors

Supercut, blunt/blunt

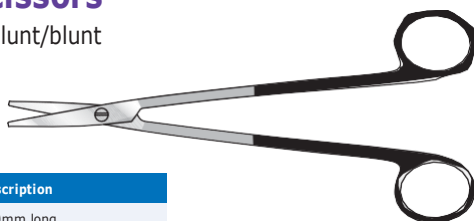

Code	Description
SC-THO/047	180mm long

## Metzenbaum Dissecting Scissors

Supercut

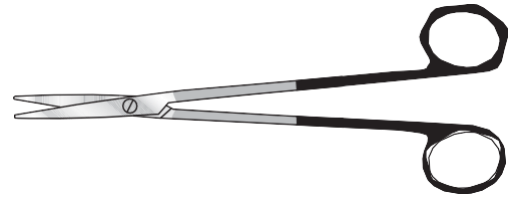

Straight (length)

Code	Description
SC-GI/190	147mm
SC-GI/188	185mm
SC-GI/188a	200mm
SC-GI/188b	230mm
SC-GI/188c	250mm
SC-GI/188d	280mm

Curved (length)

Code	Description
SC-GI/191	147mm
SC-GI/189	185mm
SC-GI/186a	200mm
SC-GI/186b	230mm
SC-GI/186c	250mm
SC-GI/186d	280mm

## Stevens Tenotomy Scissors

Supercut



Curved/blunt

Code	Description
SC-OP/424	114mm long
SC-OP/424a	125mm long
SC-OP/424gb	135mm long

Curved/sharp

Code	Description
SC-OP/425	114mm long
SC-OP/425a	140mm long
SC-OP/425b	160mm long

With cutout, 110mm long

Code	Description
SC-OP/426	Straight/blunt, 114mm long
SC-OP/427	Straight/sharp, 114mm long
SC-OP/427c	Straight/sharp, 180mm long

Code	Description
SC-OP/427a	Straight/blunt
SC-OP/427b	Curved/blunt

## Strabismus Scissors

Supercut



114mm long

Code	Description
SC-GI/475	Straight
SC-GI/475a	Curved

## Iris Scissors

Supercut

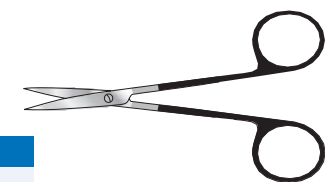

114mm long

Code	Description
SC-OP/476	Straight
SC-OP/476a	Curved

## Bruce Clarke Needle Holder

Screw joint

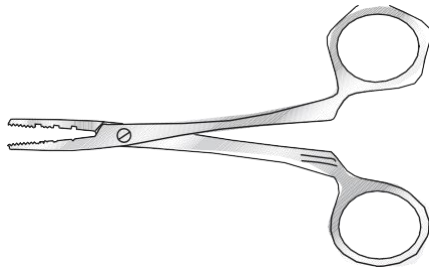

Code	Description
SC-GI/205	127mm long

## Lawrence Needle Holder

Fine jaw, 150mm long

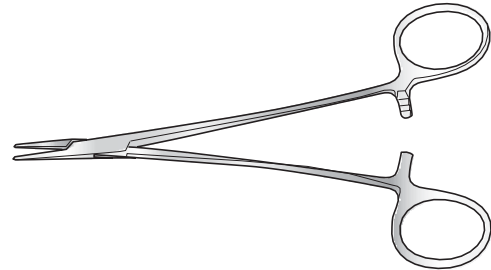

Code	Description
SC-PL/012a	
SC-PL/012b	Tungsten carbide jaw

## Crile-Wood Needle Holder

Straight, baby, fine

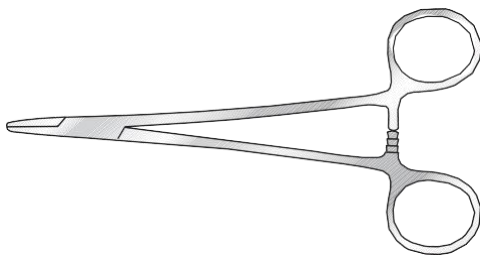

Code	Description
SC-GI/199	150mm long

## Needle Holder

Surgical Holdings pattern, box joint, lightweight, with curved plain jaws and one offset bow for thumb

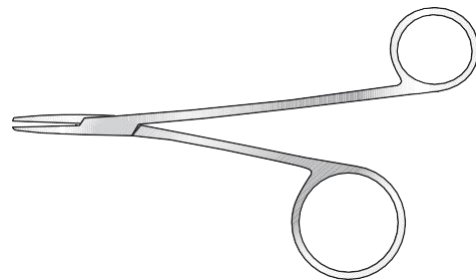

Code	Description
SC-GI/209	152mm long

## Kilner Needle Holder

Box joint, cross-serrated jaw

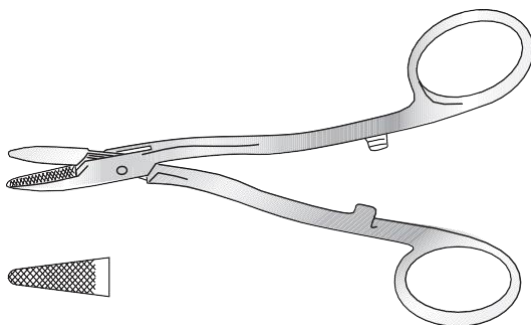

Code	Description
SC-GI/200	165mm long
SC-GI/201	133mm long

## MacPhail Needle Holder

Screw joint, with one copper jaw

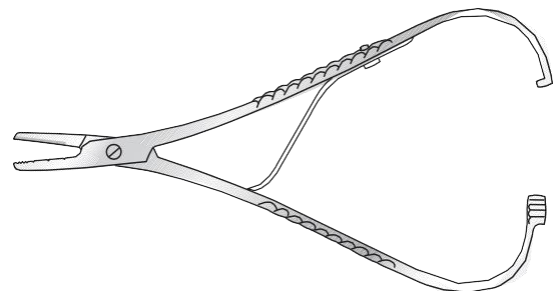

Code	Description
SC-GI/206	159mm long
SC-GI/207	178mm long
SC-GI/208	209mm long

# SAMIS INSTRUMENTS

## Mathieu Needle Holder

Screw joint

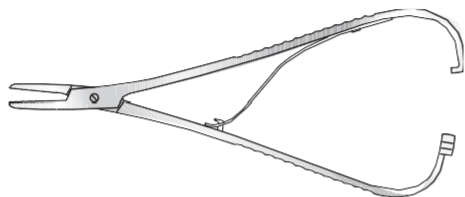

Code	Description
SC-GI/210	172mm long
SC-GI/211	209mm long
SC-GI/212	243mm long

## Naughton Morgan Needle Holder

Box joints, cross serrated jaws

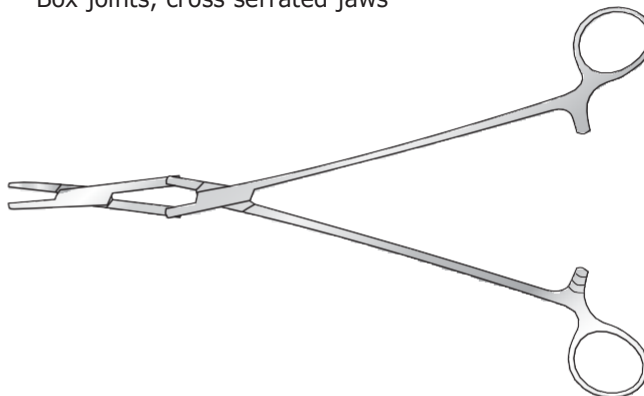

Tungsten carbide

Code	Description
SC-GI/399	185mm long
SC-GI/400	254mm long

Code	Description
SC-GI/401	185mm long
SC-GI/402	254mm long

## Mayo Needle Holder

Box joint, straight

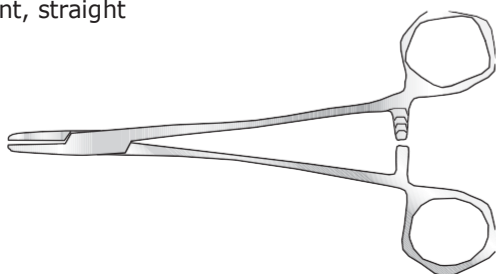

Wide cross serrated jaws

Code	Description
SC-GI/224	159mm long
SC-GI/398	203mm long

Narrow cross serrated jaws

Code	Description
SC-GI/225	159mm long

## Rochester-Mayo Needle Holder

Screw joint

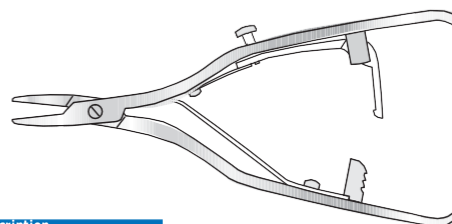

Code	Description
SC-GI/213	178mm long

## Choosing the most suitable needle size

Our tungsten carbide inserts are available in a variety of styles. Choosing the most suitable needle size for each procedure helps give the surgeon maximum grip and control.

**Coarse 0.65mm**  
For powerful needle holder patterns and wire twisters. Maximum holding capabilities for heavy needles or wire.



**Micro 0.2-0.3mm**  
For micro needle holders such as Castroviejo, Microvascular and Mini-Ryder. For delicate needles and sutures between 7-0 and 10-0.



**Standard 0.5mm**  
Used, for example, in Mayo-Hegar, Mathieu Needle Holders. For needles 3-0 and larger.



**Smooth**  
Smooth tungsten carbide surface reduces damage to delicate needles and suture of 6-0 and finer.



**Fine 0.4mm**  
For delicate needle holders such as Crile-Wood and DeBakey. For needles and sutures between 4-0 and 6-0.





WITH TWO GOLD BOWS  
FOR IDENTIFICATION

## Berry Needle Holder/Wire Twister

Tungsten carbide jaws

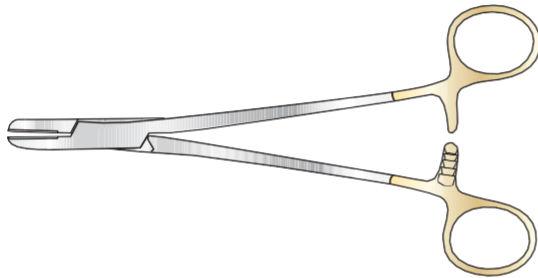

Code	Description
SC-GI/467	200mm long

## Finochietto Needle Holder

Tungsten carbide jaws

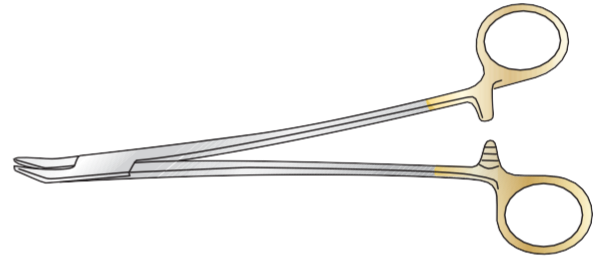

Code	Description
SC-GI/222	215mm long
SC-GI/223	265mm long

## Crile-Wood Needle Holder

Tungsten carbide insert, box joint, satin finish, straight

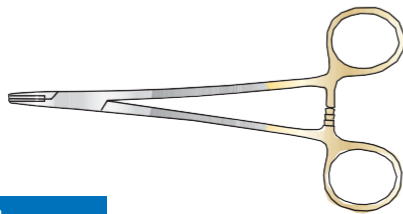

Code	Description
SC-GI/217	159mm long
SC-GI/218	178mm long
SC-GI/198	150mm long

## Halsey Needle Holder

Tungsten carbide insert, box joint, satin finish, straight

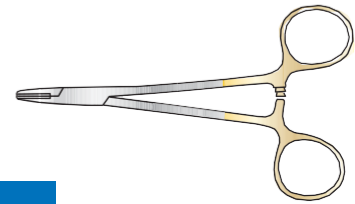

Code	Description
SC-GI/220	127mm long

## Derf Needle Holder

Tungsten carbide insert



Code	Description
SC-GI/BUPHF002	115mm long

## Kilner Needle Holder

Tungsten carbide insert

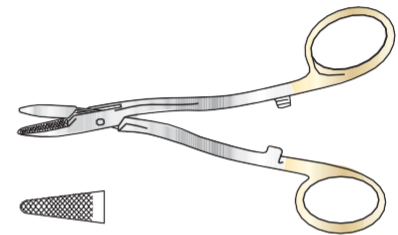

Code	Description
SC-GI/221	140mm long

# SAMIS INSTRUMENTS

**WITH TWO GOLD BOWS FOR IDENTIFICATION**

## Masing Needle Holder

Tungsten carbide insert, one angled bow

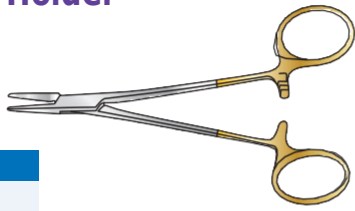

Code	Description
SC-GI/009R	130mm long

## Nievert Needle Holder

Tungsten carbide insert, box joint, satin finish, straight

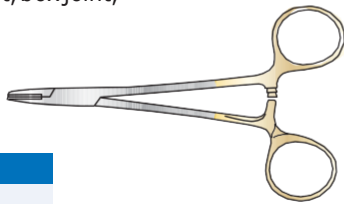

Code	Description
SC-GI/219	127mm long

## DeBakey Needle Holder

250mm long

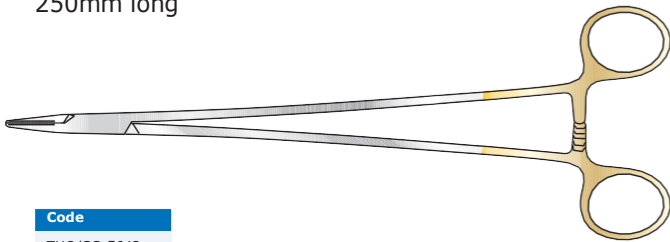

Code
THO/SC-5642a

## Ryder Needle Holder

Tungsten carbide insert, box joint, satin finish, straight

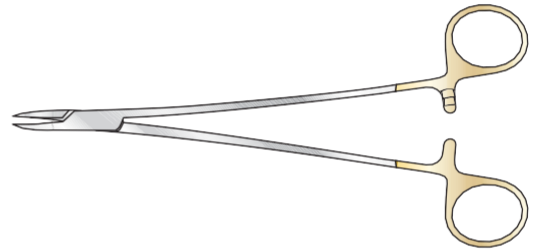

### 0.2mm jaw pitch

Code	Description
SC-GI/SH-5197a	135mm long
SC-GI/SH-5197b	155mm long
SC-GI/SH-5197c	175mm long
SC-GI/SH-5197d	210mm long

### 0.4mm jaw pitch

Code	Description
SC-GI/SH-5198a	135mm long
SC-GI/SH-5198b	155mm long
SC-GI/SH-5198c	175mm long
SC-GI/SH-5198d	210mm long

## Sarot Needle Holder

Diamond jaw, tungsten carbide, gold plated bows

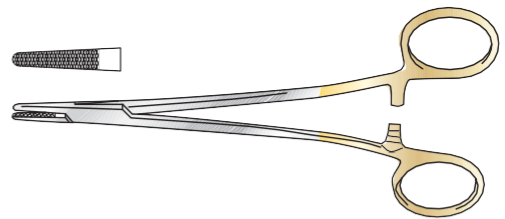

Code	Description
SC-GI/451	181mm long

## Mayo-Hegar Needle Holder

Tungsten carbide insert, box joint, satin finish, straight

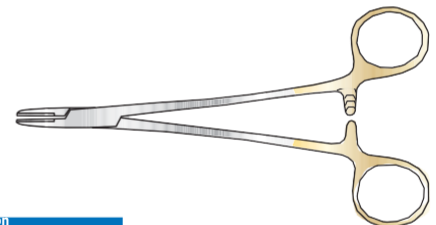

Code	Description
SC-GI/472	130mm long
SC-GI/214	159mm long
SC-GI/215	178mm long
SC-GI/216	209mm long

**LONGER SIZES AVAILABLE**

### Tungsten Carbide Needle Holders

#### Features and Benefits

- Jaw**  
Tungsten carbide inserts bonded into the jaws for a long lasting, secure grip
- Teeth**  
Fine, hard teeth, diamond cut into an insert of hardened tungsten carbide for superior needle grasping and suture tying capabilities
- Bevelled Edges**  
Prevents suture from snagging
- Vacuum Brazing**  
Combines bonding of the tungsten carbide insert with the simultaneous vacuum hardening of the instrument for greater durability and longevity
- Laser Etching**  
Date and catalogue number are etched for easy re-ordering. Laser etch will not harm instrument like traditional methods
- Shanks**  
Precision balanced for comfort and control
- Satin Finish**  
Reduces glare
- Ratchets**  
Precisely cut for effortless locking/unlocking
- Gold Handles**  
For easy identification

## Olsen-Hegar Scissor/Needle Holder

With tungsten carbide insert

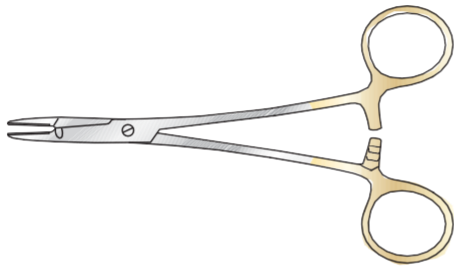

Code	Description
SC-GI/229	147mm long
SC-GI/230	165mm long

## Olsen-Hegar Scissor/Needle Holder

Screw joint

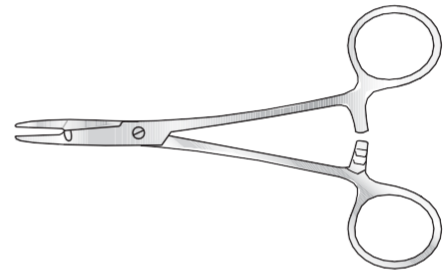

Code	Description
SC-GI/226	140mm long
SC-GI/227	165mm long
SC-GI/228	190mm long

## Gillies Scissor/Needle Holder

Right-hand, with tungsten carbide insert

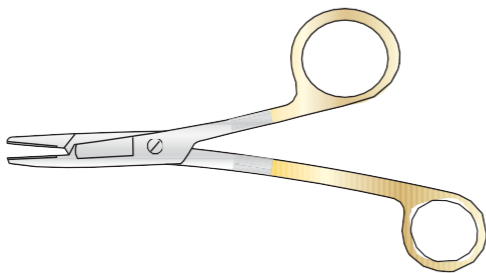

Code	Description
SC-GI/235	158mm long

## Gillies Scissor/Needle Holder

Heavy pattern, 158mm long



Code	Description
SC-GI/233	Right-hand
SC-GI/234	Left-hand

## Gillies Scissor/Needle Holder

158mm long

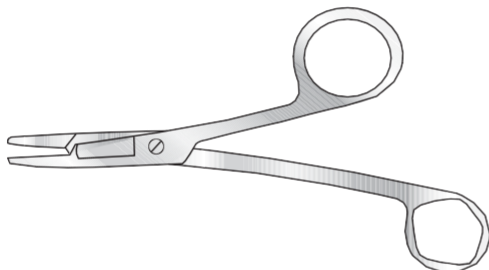

Code	Description
SC-GI/231	Right-hand
SC-GI/232	Left-hand

## Foster Gillies Scissor/Needle Holder

Fine pattern

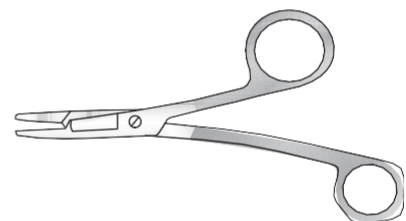

Code	Description
SC-GI/236	127mm long

# SAMIS INSTRUMENTS

## Spring Clip

Serrated pattern, stainless steel, for fixing slings to leg splints, also for towel clipping

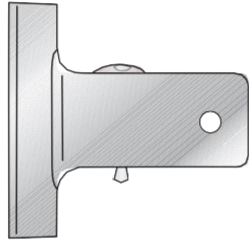

Code	Description
SC-GI/344	63mm wide

## Spring Bag Clip

Serrated



Code	Description
SC-GI/345	26mm wide

## Jones Towel Clip

Superior quality spring forcep type

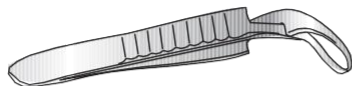

Code	Description
SC-GI/346	89mm long

## Shardles Towel Clip

Spring curved, cross action

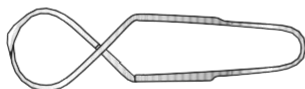

Code	Description
SC-GI/347	77mm long

## Backhaus TowelClip

Superior quality, box joint

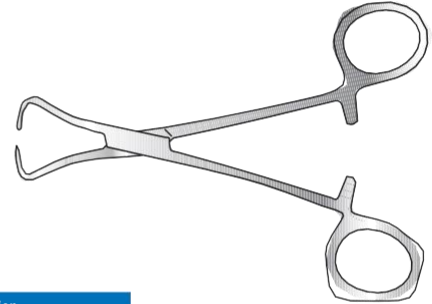

Code	Description
SC-GI/348	89mm long
SC-GI/348a	102mm long
SC-GI/349	130mm long

## Moynihan TowelClip

Screw joint, 2-2 teeth, for sides of incision

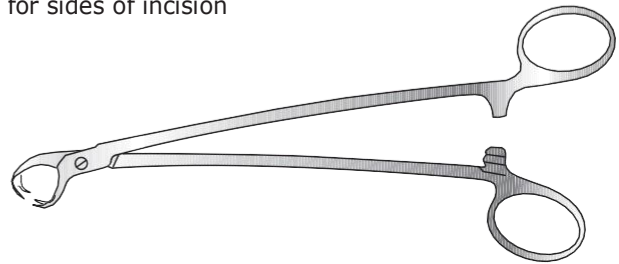

Code	Description
SC-GI/470	191mm long

## Ball and Socket Towel Forceps

Box joint

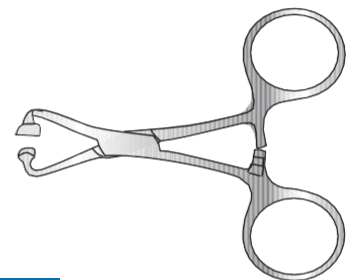

Code	Description
SC-GI/350	89mm long
SC-GI/351	115mm long
SC-GI/352	140mm long

## Goligher Retractor

Complete with 2 centre blades:  
1 x 90mm wide x 50mm deep  
1 x 90mm wide x 90mm deep

and 2 pairs of lateral blades:  
1 pair 25mm wide x 45mm deep  
1 pair 50mm wide x 90mm deep

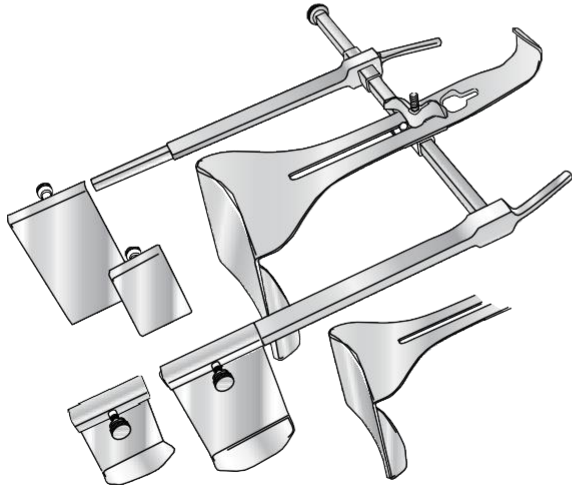

Code
SC-GI/305

## Balfour Abdominal Retractor

Trivalve, frame 203mm

### Child

102mm opening, 51mm deep lateral blades,  
38mm deep centre blade

### Adult

178mm opening, 64mm deep lateral blades,  
44mm deep centre blade

### Extra large

178mm opening, 102mm deep lateral blades,  
108mm deep centre blade

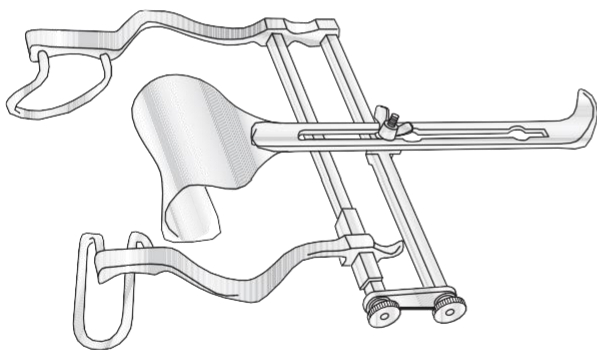

Code	Description
SC-GI/373	Child
SC-GI/374	Adult
SC-GI/375	Extra large

## Miles Retractor

Complete with 2 centre blades:  
1 x 90mm wide x 50mm deep  
1 x 90mm wide x 75mm deep

and 2 pairs of lateral blades:  
1 pair 80mm wide x 35mm deep  
1 pair 80mm wide x 75mm deep

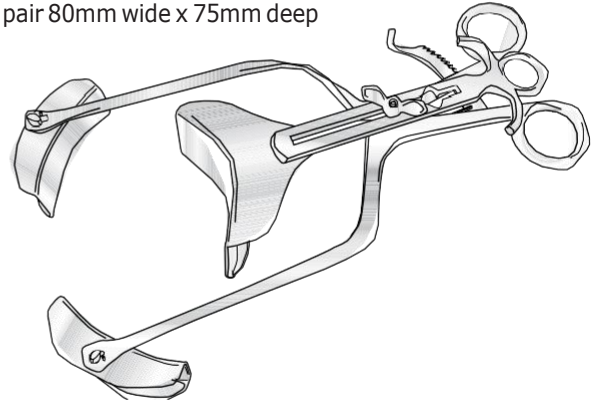

Code	Description
SC-GI/376	340mm long

OTHER BLADE SIZES AVAILABLE

## Balfour Abdominal Retractor

Bivalve, baby

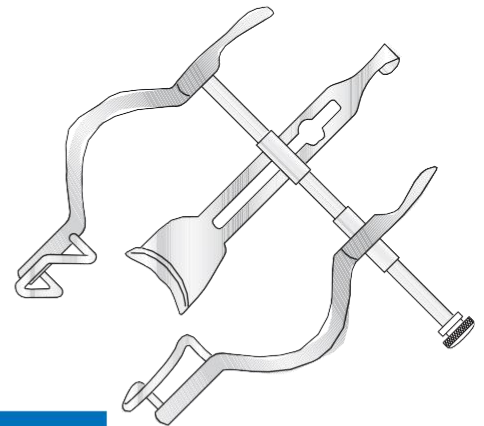

Code	Description
SC-GI/372	Fully open 89mm

## Berkeley Abdominal Retractor

Parallel action

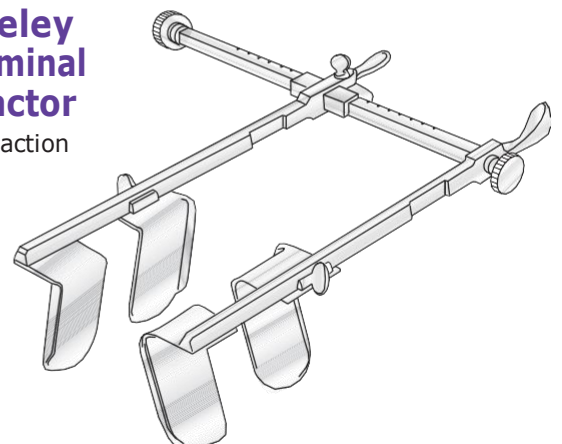

Code	Description
SC-GI/461	Blades 35mm x 60mm deep, 215mm long

# SAMIS INSTRUMENTS

## Turner Warwick Universal SelfRetaining Retractor

Code	Description
SC-GI/520	With frames A/B/C/D and blades A/B/C/D/E/F/K/L
SC-GI/521-A	Circular frame A only 178mm
SC-GI/521-B	Circular frame B only 229mm
SC-GI/521-C	Circular frame C only 305mm
SC-GI/521-D	Oval frame D only 475mm x 330mm
SC-GI/521-E	Oval frame E only 370mm x 300mm

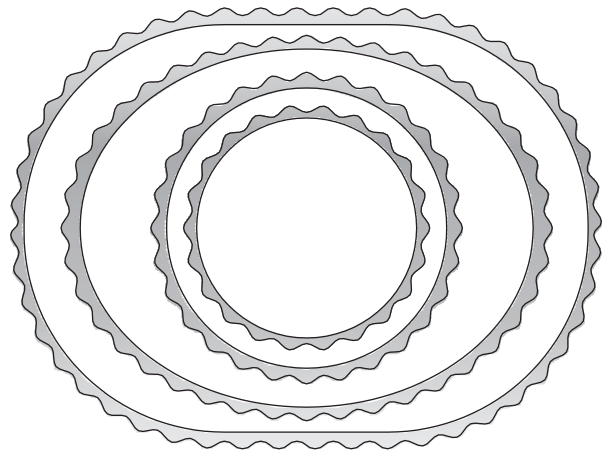

## Turner Warwick Needleholder with Tungsten Carbide Jaws

Curved shanks with one short bow

Code	Description
SH-5835	230mm long
SH-5835A	200mm long

### Blade A



Code	Description
SC-GI/522-A	Blade only - 19mm x 76mm

### Blade B

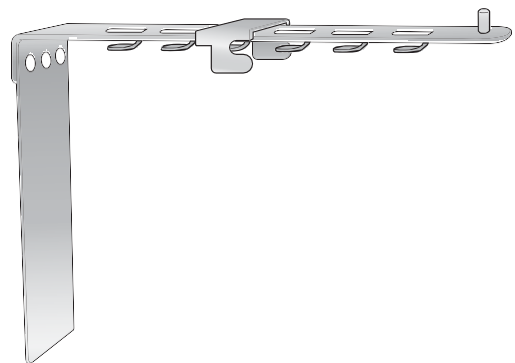

Code	Description
SC-GI/522-B	Blade only - 38mm x 102mm

### Blade C

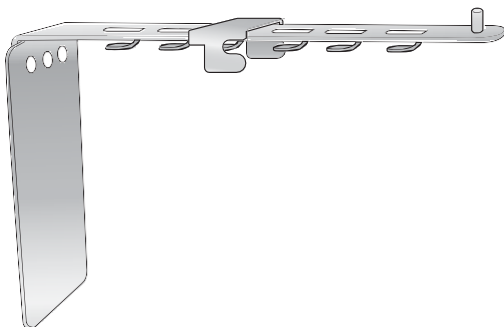

Code	Description
SC-GI/522-C	Blade only - 57mm x 89mm

### Blade D

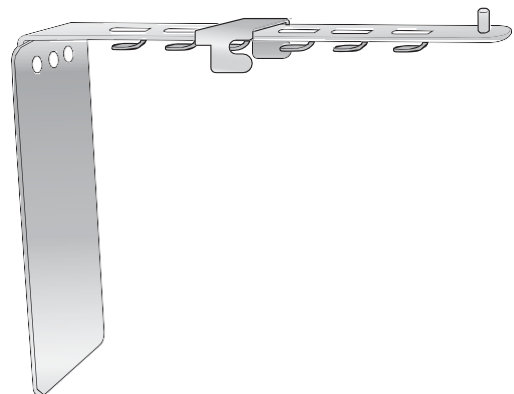

Code	Description
SC-GI/522-D	Blade only - 57mm x 114mm

## Blade E

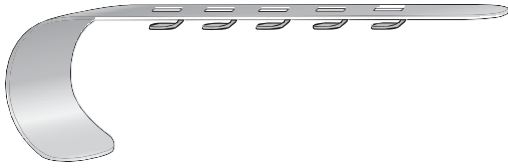

Code	Description
SC-GI/522-E	Blade only - curved stainless steel blade 51mm x 38mm

## Blade F

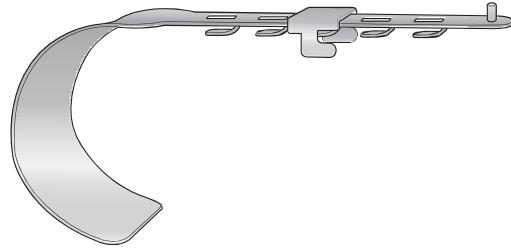

Code	Description
SC-GI/522-F	Blade only - curved stainless steel blade 76mm x 60mm

## Blade G

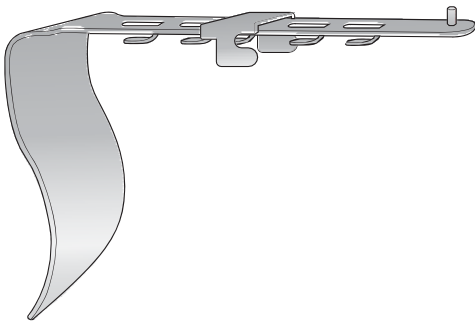

Code	Description
SC-GI/522-G	Blade only - flat stainless steel blade 89mm x 60mm

## Blade J



Code	Description
SC-GI/522-J	Blade only - single hook, 13mm deep

## Blade K

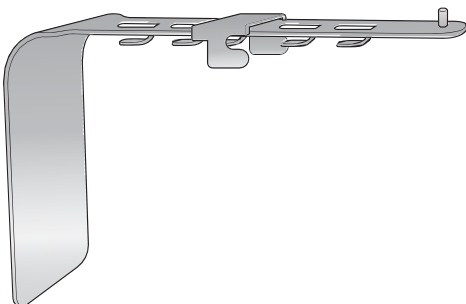

Code	Description
SC-GI/522-K	Blade only - flat with clip 55mm x 90mm

## Blade L

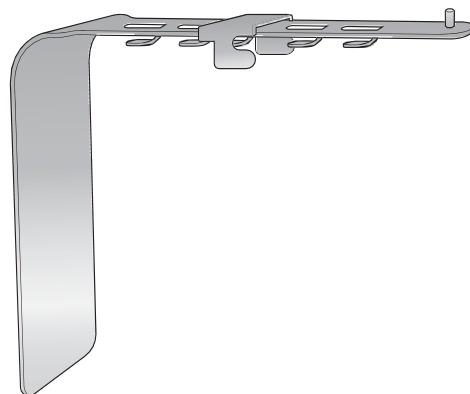

Code	Description
SC-GI/522-L	Blade only - flat with clip 55mm x 120mm

# SAMIS INSTRUMENTS

## Collin Retractor

110mm fully open, 235mm long

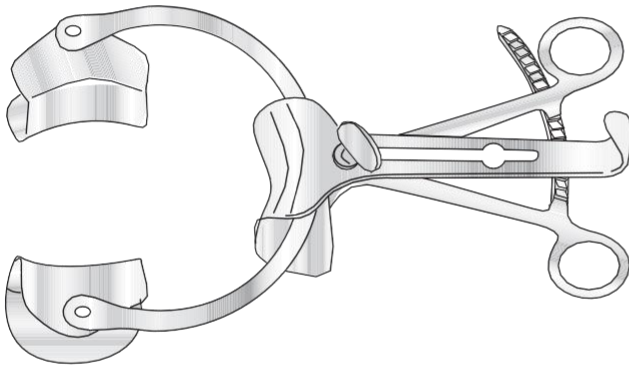

Code	Description
SC-GI/322	Complete with centre blade 55 x 40mm and one pair of blades 38mm x 60mm
SC-GI/322a	Without centre blade

## Joll Thyroid Retractor

Self retaining, with lock-in nut

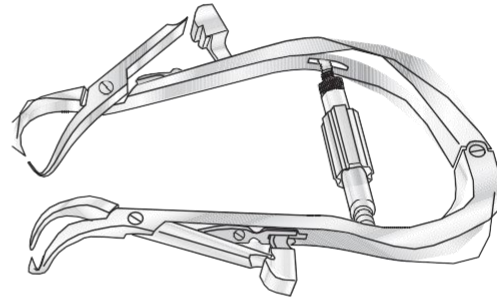

Code	Description
SC-GI/363	152mm long

## Gelpi Retractor

Self retaining

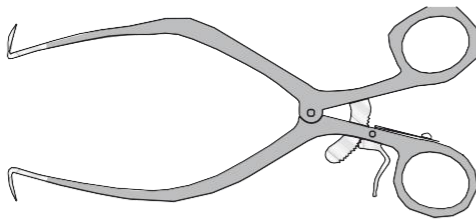

Code	Description
SC-GY/013a	140mm long
SC-GY/013b	178mm long

## Gossett Abdominal Retractor

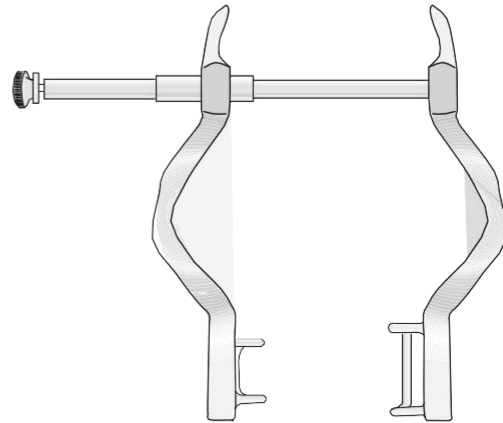

Code	Description
SC-GI/303	Large, fully open 185mm long
SC-GI/304	Small, fully open 95mm long

## Pozzi Abdominal Retractors

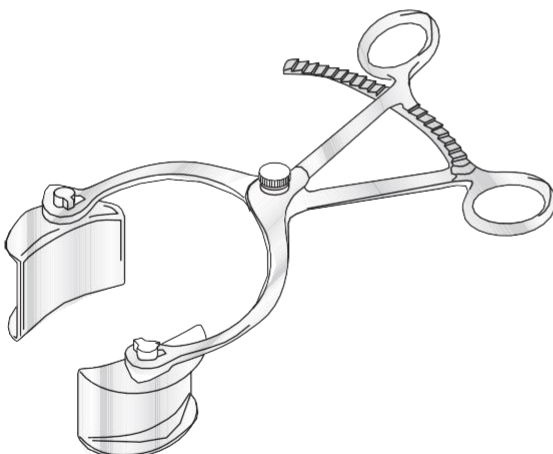

Code	Description
SC-GI/370	Swivel blades: 38 x 60mm, bivalve, 254mm long

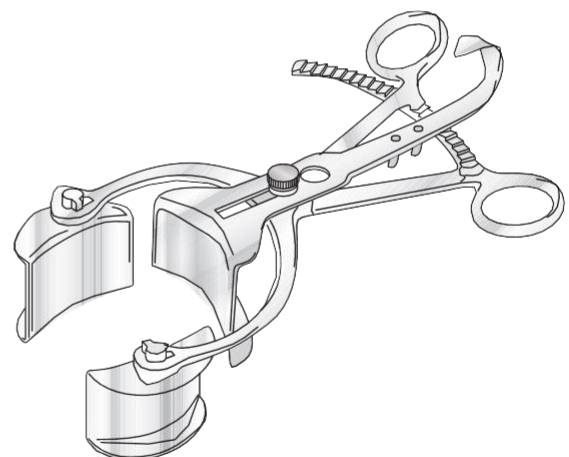

Code	Description
SC-GI/371	Swivel blades: 38 x 59mm, trivalve, 203mm long

## Bowlby Dilator

Curved

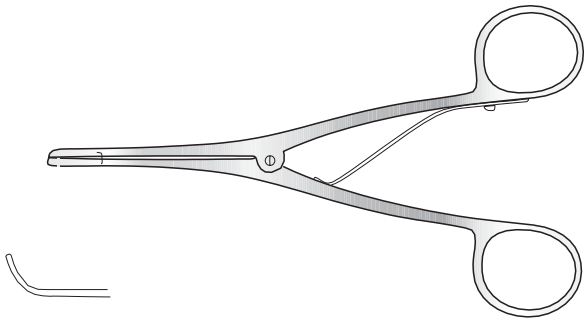

Code	Description
SC-GI/495	145mm long

## Travers Retractor

Self retaining with internal rack, 210mm long

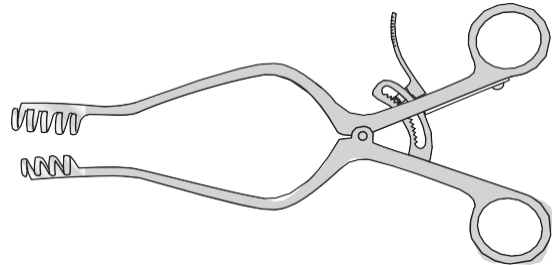

Code	Description
SC-GI/323	4 x 5 teeth, 95mm fully open

## Irwin Retractor

Self retaining, with cam rack, 4 x 4 teeth

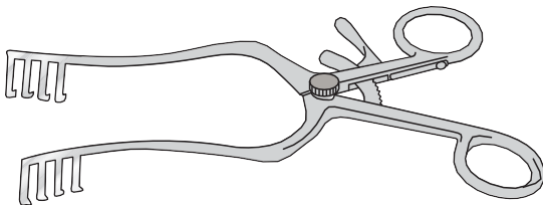

Code	Description
SC-GI/324	178mm long

## West Retractor

Self retaining, 140mm long

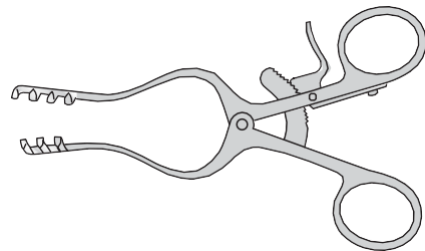

Code	Description
SC-GI/326	3 x 4 teeth, 60mm fully open
SC-GI/326cr	3 x 4 teeth, 60mm fully open, with cam rack

## Norfolk and Norwich Retractor

4 x 5 teeth 50mm blades x 223mm long

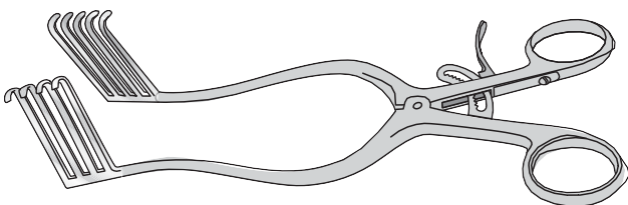

Code	Description
SC-GI/325	Standard rack

## Weitlander Retractor

3-4 teeth

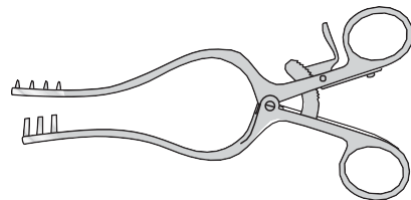

135mm long

Code	Description
SC-GI/496	Blunt
SC-GI/496a	Sharp
SC-GI/496b	Sharp, 2-3 teeth
SC-GI/496c	Blunt, 2-3 teeth

165mm long

Code	Description
SC-GI/497	Blunt
SC-GI/497a	Sharp

# SAMIS INSTRUMENTS

## Kocher Retractor

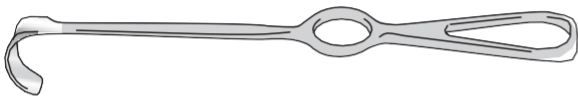

230mm long

Code	Description
SC-GI/378	36 x 20mm blade

250mm long

Code	Description
SC-GI/378a	67 x 25mm blade
SC-GI/378b	80 x 42mm blade
SC-GI/378c	80 x 50mm blade
SC-GI/378d	80 x 60mm blade

## Kocher Langenbeck Retractor

215mm long

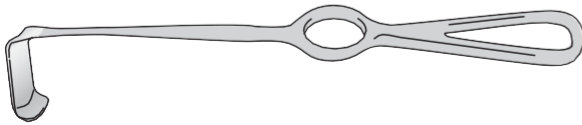

Code	Description
SC-GI/336sp	25 x 6mm blade
SC-GI/379a	35 x 8mm blade
SC-GI/379b	35 x 11mm blade
SC-GI/379c	35 x 15mm blade
SC-GI/357sp	41 x 11mm blade

Code	Description
SC-TH0/cutsp015	55 x 11mm blade
SC-GI/379d	70 x 15mm blade
SC-GI/379e	80 x 12mm blade
SC-GI/379f	80 x 16mm blade

## Langenbeck Retractor

Single ended



Code	Description
SC-GI/336	Blade 22mm x 6mm
SC-GI/337	Blade 45mm x 13mm
SC-GI/337a	Blade 65mm x 13mm
SC-GI/338a	Blade 75mm x 25mm
SC-GI/338a1	Blade 65mm x 25mm

## Landon Retractor

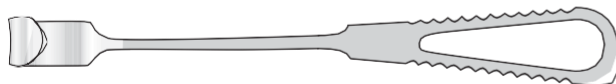

Code	Description
SC-GI/494	230mm



## Canny Ryall Navy Retractor

Double-ended, with one single hook blade 5mm wide, and one fenestrated blade

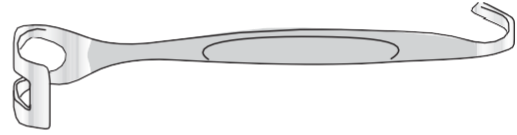

Code	Description
SC-GI/343	Fenestrated blade 16mm wide, 190mm long
SC-GI/343a	Fenestrated blade 19mm wide, 190mm long
SC-GI/343b	Fenestrated blade 25mm wide, 220mm long
SC-GI/343c	Fenestrated blade 30mm wide, 220mm long

## Canny Ryall Army Retractor

Double prong, 13mm wide, 165mm long



Code	Description
SC-GI/342	Large, 19mm wide
SC-GI/342a	Small, 11mm wide

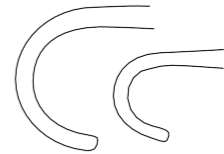

## Czerny Retractor

Double ended

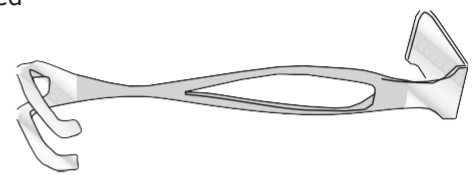

Code	Description
SC-GI/341	171mm long

## Lane Retractor

Double ended blade, 229mm long

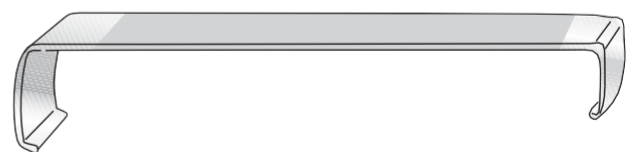

Code	Description
SC-GI/339	13mm x 19mm wide
SC-GI/340	25mm x 32mm wide

## Morris Retractor

Singleblade, 229mm long

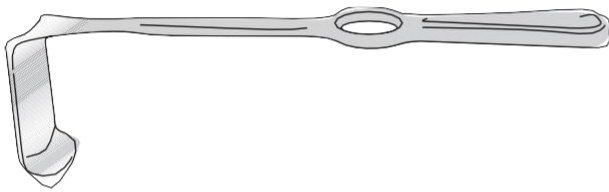

Code	Description
SC-GI/330	38 x 51mm
SC-GI/331	51 x 51mm
SC-GI/332	64 x 51mm

## Morris Retractor

Double ended, 216mm long

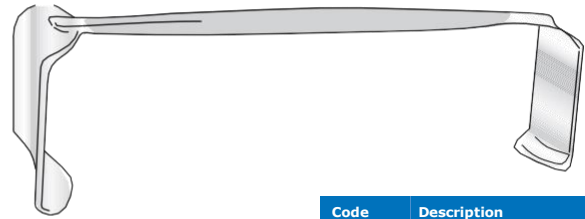

Code	Description
SC-GI/327	32 x 51mm and 38 x 51mm
SC-GI/328	44 x 51mm and 51 x 51mm
SC-GI/329	64 x 51mm and 38 x 51mm

## Moynihan Retractor

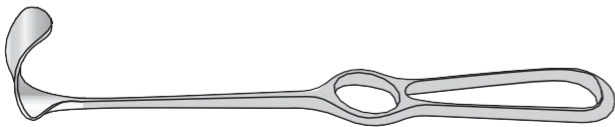

Code	Description
SC-GI/462	Single ended, blade 13 x 22mm, 215mm long

## Deaver Abdominal Retractors



Code	Description
SC-GI/306	Set of 5, 315mm overall length
SC-GI/307	25mm wide
SC-GI/308	25mm wide
SC-GI/309	38mm wide
SC-GI/310	51mm wide
SC-GI/311	76mm wide

## Elliot (Modified Deaver) Retractor

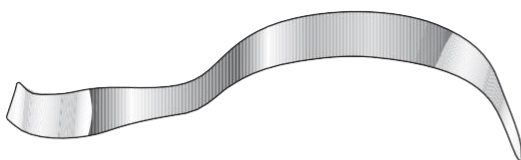

Code	Description
SC-GI/308M	With flat handle

## Dyball and Lock Retractor

For liver



Code	Description
SC-GI/335 64	x 144mm, 241mm long

OTHER SIZES AVAILABLE - PRICE ON APPLICATION

## Deaver Abdominal Retractors

With round handles

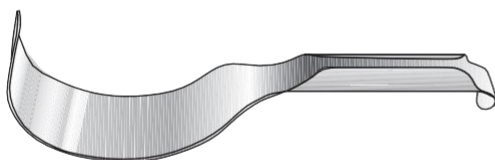

Code	Description
SC-GI/312	Set of 5, 305mm overall length
SC-GI/313	25mm wide
SC-GI/314	25mm wide
SC-GI/315	38mm wide
SC-GI/316	51mm wide
SC-GI/317	76mm wide

## Kelly Retractor Blade

267mm long

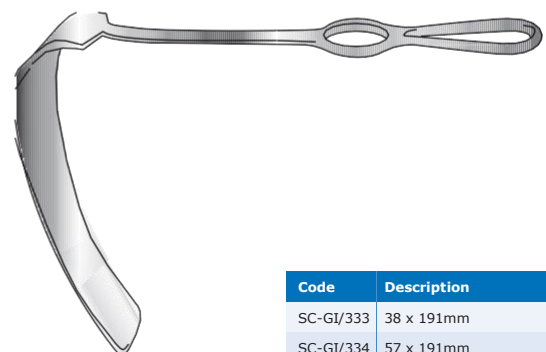

Code	Description
SC-GI/333	38 x 191mm
SC-GI/334	57 x 191mm

# SAMIS INSTRUMENTS

## Durham Retractor

With fenestrated blade, 216mm long

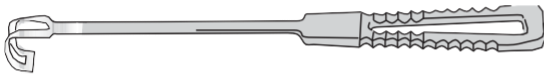

Code	Description
SC-GI/300	10mm wide
SC-GI/301	14mm wide
SC-GI/302	20mm wide

## Ballance (Volkman) Retractor

203mm long



### Sharp

Code	Description
SC-GI/463	1 prong
SC-GI/463a	2 prong
SC-GI/463b	3 prong
SC-GI/463c	4 prong
SC-GI/463d	6 prong

### Blunt

Code	Description
SC-GI/463e	1 prong
SC-GI/463f	2 prong
SC-GI/463g	3 prong
SC-GI/463h	4 prong
SC-GI/463i	6 prong

## Volkman Retractor



Code	Description
SC-OR/400	Sharp, 220mm long
SC-OR/400a	Blunt, 220mm long
SC-OR/400b	Sharp, 245mm long

## Kilner Retractor

Double ended, cat's paw



Code	Description
SC-PL/056	152mm long

## Kocher Retractor



Code	Description
SC-OR/N036c	Sharp, 205mm long
SC-OR/N036	Sharp, 220mm long
SC-OR/N036b	Blunt, 220mm long

## Senn-Miller Retractor

170mm long



Code
SC-SH/5881

## Single Hook Retractor

Sharp



Code	Description
SC-GI/SH5671	152mm long
SC-PL/065b	Half size, fine

## Gillies Skin Hook

Solid handle, 190mm long



Code	Description
SC-PL/065a	Standard, fine
SC-PL/065b	Half size, fine

## MacDonald Dissector Double Ended



Code	Description
SC-GI/285	191mm long

## Probe, Sinus Silver



Code	Description
SC-GI/464	152mm long

## Brodie Director Probe Ended, Silver Plated



Code	Description
SC-GI/286	165mm long

## Probe, Fish Tail Silver Plated



Code	Description
SC-GI/293	127mm long
SC-GI/294	152mm long
SC-GI/295	203mm long
SC-GI/296	254mm long

## Watson Cheyne Dissector

Fine, double-ended, with probe end



Code	Description
SC-GI/287	127mm long
SC-GI/288	191mm long
SC-GI/288a	230mm long
SC-GI/288b	255mm long

## Jobson Horne Probe Dressing (Aural)

With one flat tapered end, serrated edge and one small ring end, stainless steel



Code	Description
SC-GI/297	140mm long
SC-GI/298	178mm long

## Probe, Malleable Silver Plated



Code	Description
SC-GI/289a	127mm long
SC-GI/289	152mm long
SC-GI/290	178mm long
SC-GI/291	203mm long
SC-GI/292	255mm long
SC-GI/292a	305mm long

## Bookwalter® Retractor Kit III

A table-fixed retractor system designed by surgeons to efficiently and reliably hold surgical instruments in place during surgery while allowing greater visibility.

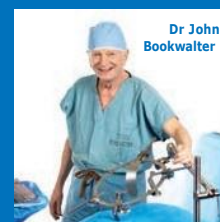

Kit includes Bookwalter® Kit: Table Post and Coupling, Horizontal Flex Bar, Segmented Rings, Tilt Ratchet Mechanism, Kelly Retractors, Blades and Ratchets

Contact us for full details

# SAMIS INSTRUMENTS

## Aneurysm Needle

Small, for infusions



Code	Description
SC-GI/472a	146mm long

## Syme Aneurysm Needle

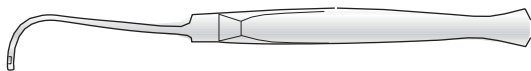

Code	Description
SC-GI/473	165mm long

## Ring Cutter

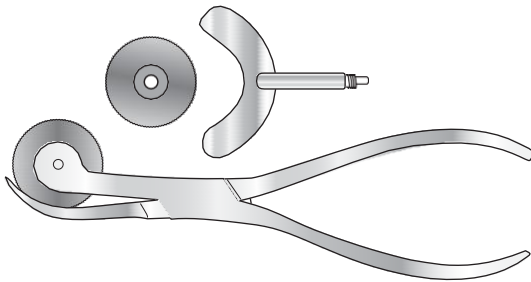

Code	Description
SC-GI/452	Circular saw blade, 165mm long
SC-GI/452a	Spare blade

## Mayo Instrument Pin

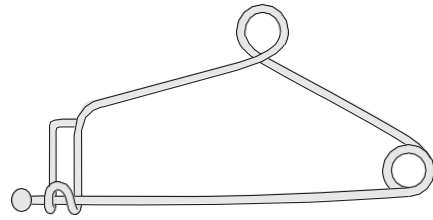

Code	Description
SC-GI/355	102mm long
SC-GI/356	152mm long

## Baron Scalpel Handle

130mm long



Code	Description
SC-PM/003	No 3
SC-PM/004	No 4

## Scalpel Handle

127mm long

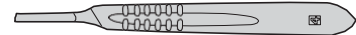

Code	Description
SC-PM/007	No 3
SC-PM/008	No 4
SC-PM/008a	No 4 L
SC-PM/001a	No 7

## Endoscope Re-fibre

Surgical Holdings manufacture their own fibre bundles in house. We cover small and larger diameter scopes and only use high quality German fiberoptic material and stainless steel tubing.

- |  |   |
|--|---|
| Quality components, globally sourced:  | 4 New solderable sapphire distal window   |
| 4 Medical grade stainless steel tubing | 4 New light post colour ring              |
| 4 German engineered new glass fibre    | 4 New objective in 95% of cases           |
| 4 New fibre cone as standard           | 4 Replacement 'O' ring to prevent leakage |



After repair

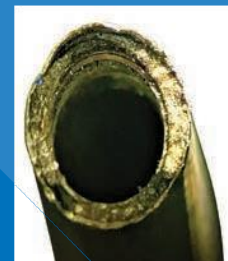

Before repair

Contact us with your requirements  
[MAIL@SAMISINSTRUMENTS.COM](mailto:MAIL@SAMISINSTRUMENTS.COM)

## Kidney Dish

Stainless steel

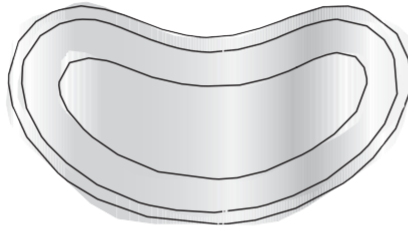

Code	Description
SC-GI/380	152mm
SC-GI/381	203mm
SC-GI/382	254mm
SC-GI/383	305mm

## Cheate Jar

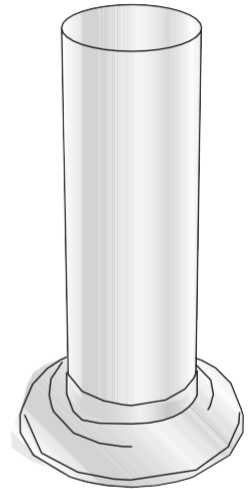

Code	Description
SC-GI/397	Stainlesssteel, 203mmx50mm

## Lotion Bowl

Without lid, stainless steel

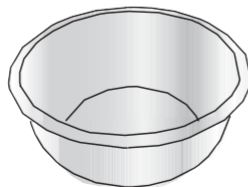

Code	Description
SC-GI/384	102mm
SC-GI/385	152mm
SC-GI/386	203mm
SC-GI/387	254mm
SC-GI/388	305mm

## Measuring Jug

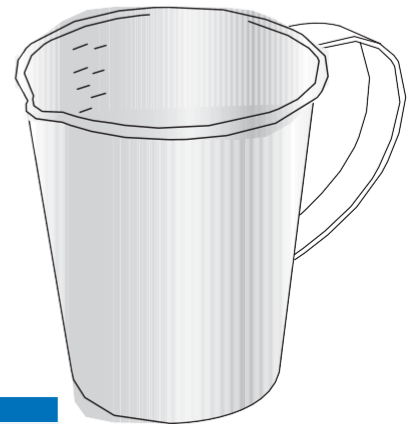

Code	Description
SC-GI/395	1 litre capacity

## Instrument Tray

Stainless steel

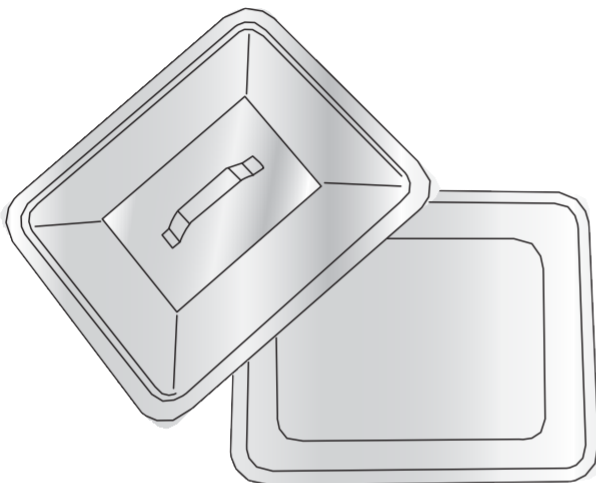

Code	Description
SC-GI/389	254 x 203 x 50mm
SC-GI/390	Lid only for 254 x 203 x 50mm
SC-GI/391	305 x 254 x 50mm
SC-GI/392	Lid only for 305 x 254 x 50mm
SC-GI/393	356 x 305 x 50mm
SC-GI/394	Lid only for 356 x 305 x 50mm

## Petri Dish



Code	Description
SC-SH/002149	100mm, stainless steel, with lid

## Gallipot

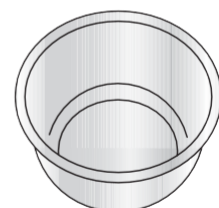

Code	Description
SC-GI/396	Stainless steel, 63mm

# SAMIS INSTRUMENTS

## Silicone Matting

Medical grade for storage, sterilisation and transportation of instruments.



SILICONE MATTING AVAILABLE FOR ALL BASKETS - PLEASE ASK FOR PRICE

Cushion, protect, and organise delicate surgical instruments during storage, transportation, and sterilisation. Perforations allow for ventilation during the sterilisation process. The silicone mat can be cut to fit any size container.

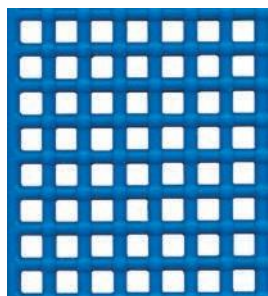

502mm long x 242mm wide  
7mm holes, 10mm between holes

Code

BES/1004M

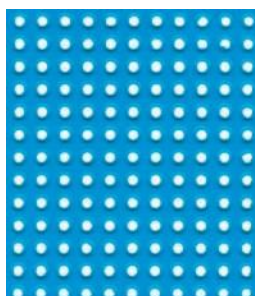

515mm long x 240mm wide  
3mm holes, 6mm between holes

Code

BES/1001M



570mm long x 550mm wide  
4mm holes, 13mm between holes

Code

BES/1002M

## Sterilising Baskets

### DIN Basket

Wire mesh base with perforated sides and two carrying handles

Code	Description
SC-GI/C0006	230 x 130 x 60mm
SC-GI/C0007	240 x 130 x 50mm
SC-GI/C0008	240 x 130 x 60mm
SC-GI/C0009	240 x 250 x 50mm
SC-GI/C0010	240 x 250 x 60mm
SC-GI/C0014	300 x 300 x 50mm
SC-GI/C0015	350 x 350 x 60mm
SC-GI/C0011	480 x 250 x 50mm
SC-GI/C0012	480 x 250 x 60mm

Code	Description
SC-GI/C0013	480 x 250 x 70mm
SC-GI/C0016	480 x 400 x 60mm
SC-GI/C0017	480 x 480 x 50mm
SC-GI/C0018	480 x 480 x 60mm
SC-GI/C0019	500 x 300 x 50mm
SC-GI/C0020	550 x 430 x 50mm
SC-GI/C0021	600 x 300 x 60mm



### DIN Basket

Wire mesh basket with two carrying handles

Code	Description
SC-GI/C0022	240 x 250 x 50mm
SC-GI/C0023	240 x 250 x 60mm
SC-GI/C0024	240 x 250 x 70mm
SC-GI/C0031	300 x 300 x 60mm
SC-GI/C0025	480 x 250 x 50mm

Code	Description
SC-GI/C0026	480 x 250 x 60mm
SC-GI/C0027	480 x 250 x 70mm
SC-GI/C0028	480 x 250 x 100mm
SC-GI/C0029	480 x 480 x 50mm
SC-GI/C0030	480 x 480 x 70mm

### DIN Basket Lids

For perforated and wire mesh baskets

Code	Description
SC-GI/C0032	240 x 250mm
SC-GI/C0033	300 x 300mm
SC-GI/C0034	480 x 250mm
SC-GI/C0035	480 x 480mm

Did you know...

**Organising and fixing instruments in place can aid the cleaning process.**

Help keep your instruments in good condition for longer with our baskets and trays. Available in custom sizes, to suit your requirements perfectly.

EMAIL [SAMISINSTRUMENTS.COM](mailto:SAMISINSTRUMENTS.COM)

## ENT Basket

Wire mesh base with perforated sides and two carrying handles, supplied with lid

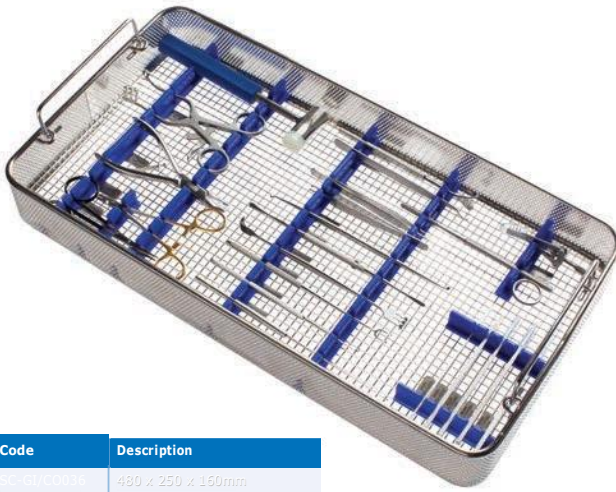

Code	Description
SC-GI/CO036	480 x 250 x 150mm
SC-GI/CO037	Fixing clamps

## Arthroscope Basket

Wire mesh base with two fixing clamps



Code	Description
SC-GI/CO001	290 x 80 x 52mm

## Endoscope Basket

With small lens basket

Code	Description
SC-GI/CO002	6400 x 150 x 77mm

Wire mesh base with two fixing clamps

Code	Description
SC-GI/CO003	S - 460 x 80 x 52mm
SC-GI/CO004	D - 480 x 80 x 52mm
SC-GI/CO005	D - 680 x 80 x 52mm

## Sieve

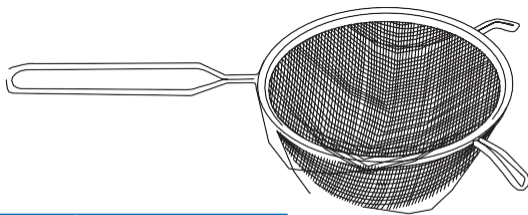

Code	Description
SC-GI/5071	203mm x 50mm ø

## Fine Mesh Basket



With hinged take off / lockable lid

Code	Description
SC-GI/CO041	120 x 155 x 40mm
SC-GI/CO044	120 x 155 x 50mm
SC-GI/CO042	235 x 155 x 40mm
SC-GI/CO045	235 x 155 x 50mm
SC-GI/CO043	375 x 260 x 40mm

With separatelid

Code	Description
SC-GI/CO038	120 x 155 x 40mm
SC-GI/CO039	235 x 155 x 40mm
SC-GI/CO040	375 x 260 x 40mm

## Symmetry Surgical Quadlock Containers



Surgical Holdings offer the unique Quadlock container. The Patented design offers 4 locks, as opposed to the traditional 2, to ensure extra security and peace of mind.

Contact us for full spec and to order  
EMAIL  
SAMISINSTRUMENTS.COM



WE ALSO MAKE CUSTOM BASKETS AND TRAYS,  
CONTACT US TO DISCUSS YOUR REQUIREMENTS

# SAMIS INSTRUMENTS

Our optical fibre cables are compatible with all major scopes and illuminators. Every light lead is high temperature xenon compatible, rated to the highest level of thermal resistance and tested to ensure the highest light output possible.

**Choice of 10 colours for easy identification**

**Choice of lengths and sheathing types**

**1 YEAR MANUFACTURER'S WARRANTY**

**Free on-site light lead testing**  
We'll come and go through your lead stock to ensure your leads are fit for use

**Reinforced for longer life**

## How to order

Select an option from each step to create your part number.

*Example: 474810180FRGY is a Storz Proximal, Storz Distal, 4.8mm Bundle, 254mm Length, Fully Reinforced Sheathing in Grey*

### Step 1: Proximal/Illuminator Connector

**1** ACMI / Circon

**2** Wolf / Dyonics

**L2** Wolf / Long

**3** Olympus / ACMI

**4** Storz

**5** Pilling

**U** Universal\*

\*A screw-on adapter is necessary for this connector and must be ordered separately

## Step 2: Distal/Instrument Connector

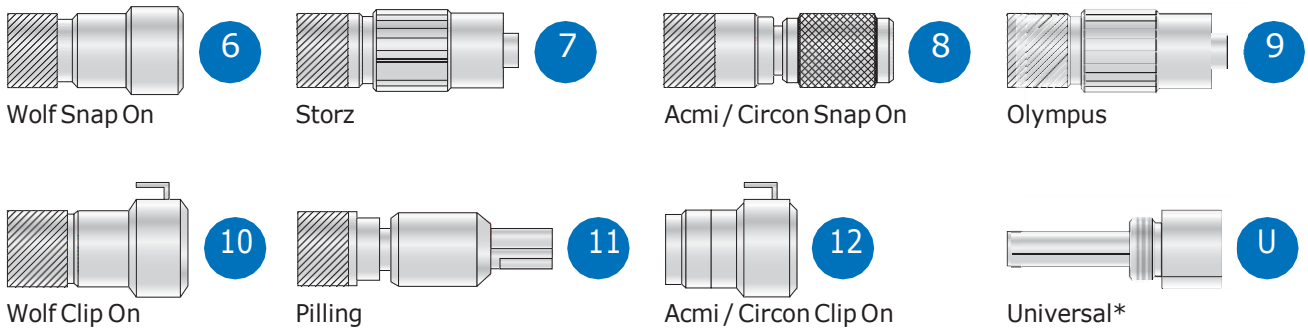

\*A screw-on adapter is necessary for this connector and must be ordered separately

## Step 3: Fibre Optic Bundle Size

Place gauge on bundle to determine diameter

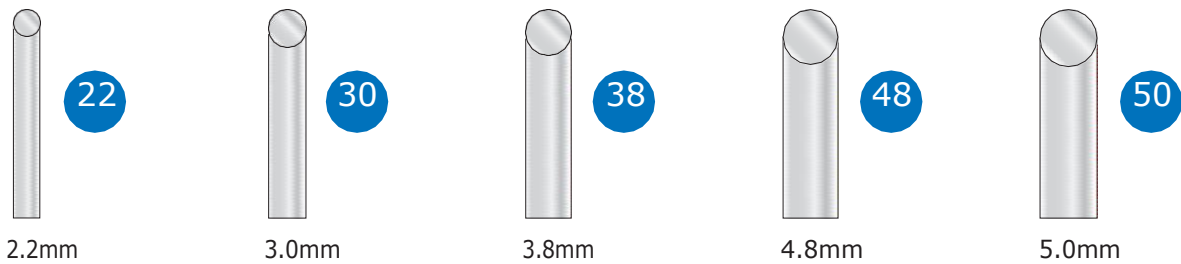

## Step 4: Fibre Optic Cable Length

Custom lengths available

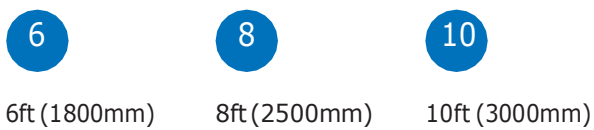

## Step 5: Instrument Connector Angle

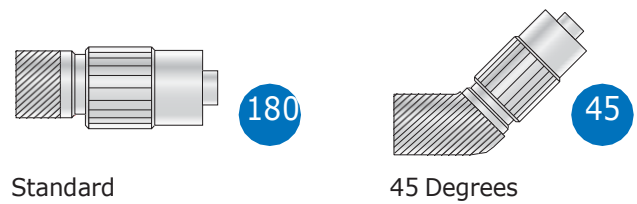

## Step 6: Sheathing Type

- 0 Non-reinforced
- 6 152mm Reinforced Ends
- FR Fully Reinforced

## Step 7: Sheathing Colour

